

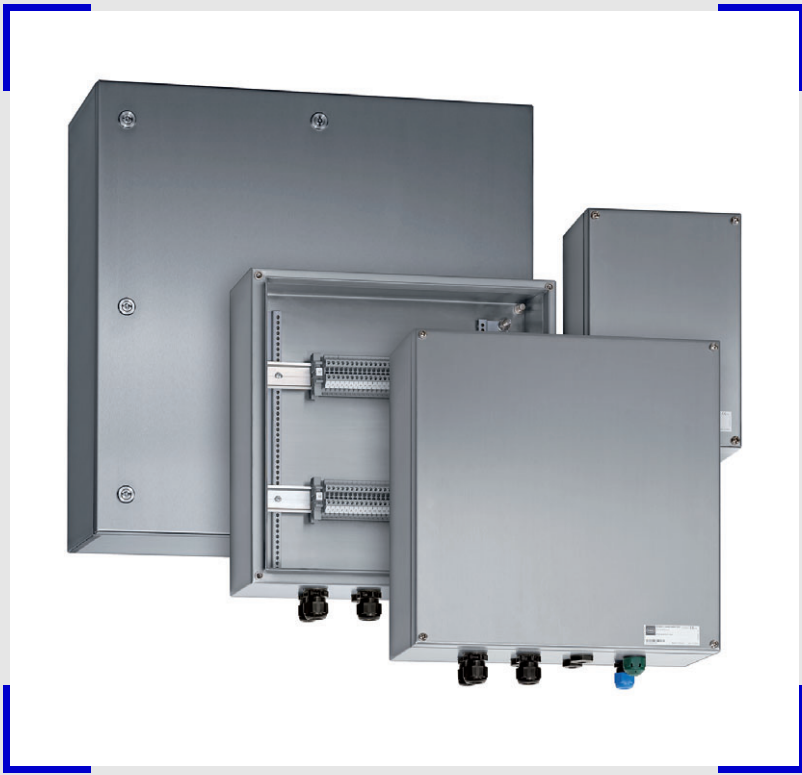

Terminal Boxes
 Series 8150

www.stahl.de



12667E00

- > Enclosures made of stainless steel, brush finished 1.4301 (AISI 304) or 1.4404 (AISI 316L)
- > Optionally with hinges / cam lock or screw-on cover
- > Hinge versions with large opening angle 130°
- > Extended ambient temperature range due to high-quality seal materials
- > Circumferential protection channel prevents water entry
- > External earth connection M8
- > Flange plate tightened from the outside enables simple installation
- > Degree of protection IP66



E3

	ATEX / IECEx						NEC 505 Class I						NEC 506						NEC 500					
	0	1	2	20	21	22	0	1	2	20	21	22	1	2	1	2	1	2						
Zone																								
For use in		x	x		x	x		x	x															

WebCode 8150A

Terminal Boxes

Series 8150

Advantages of the Series 8150



The new form of the edges allows quick water drainage and prevents water from accumulating around the gasket. This solution helps to increase the safety inside the enclosure.

12660E00



The flange plate mounted from the outside is another advantage of this enclosure: This guarantees a perfect accessibility - even if the cables are already built-in.

13128E00



The large beam width allows you a comfortable access and an easy and fast handling.

13130E00

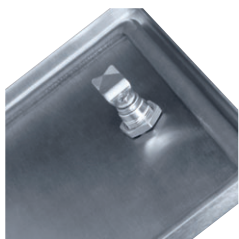

If a regular access is required, the version equipped with a sash lock (or a hinge) is recommended.

12659E00



The earth connection M8 is already included in the delivery. In addition, there are different mounting possibilities.

13129E00



The locking device is designed for locking of sash locks by means of padlocks. They can be installed and retrofitted easily.

16639E00

Terminal Boxes

Series 8150



Advantages of the Series 8150



16636E00

Enclosures which are opened upwards must be equipped with a cover support. It can be used to hold the enclosure cover open in different positions.



16959E00

The modular design of the sunroof system allows several enclosures to be covered simultaneously. This sunroof system can be retrofitted at any time. The bayonet hanging system allows easy and quick mounting.



17721E00

As an option, the terminal box is available with interior fittings of Z and mounting rails made of 1.4404 (AISI316L) stainless steel.



17812E00



17813E00

Label holder bride for retrofitting of labels. The label holder is available upon request and therefore allows an easy installation of the labels on site. The label holder is also available in different sizes.

E3

Terminal Boxes

Series 8150

Order number supplement

8150/1-.....-3.1	Ex e or Ex e ia/lb version
8150/2-.....-3.1	Ex i version
8150/-.....-3.1	Dimension side C/D
8150/-.....-3.1	Dimension side A/B
	<div style="display: flex; justify-content: space-around;"> <div style="text-align: center;"> <p>without hinge</p> <p>13020E00</p> </div> <div style="text-align: center;"> <p>13021E00</p> </div> <div style="text-align: center;"> <p>with hinge</p> <p>13022E00</p> </div> <div style="text-align: center;"> <p>13023E00</p> </div> </div> <p>I = hinge</p>
8150/-.....-091-3.1	Depth 91 mm
8150/-.....-150-3.1	Depth 150 mm
8150/-.....-190-3.1	Depth 190 mm
8150/-.....-230-3.1	Depth 230 mm
8150/-.....-2...	Stainless steel 1.4301
8150/-.....-3...	Stainless steel 1.4404
8150/-.....-3..	Brushed (line pattern)
8150/-.....-1.	Cover fixed with screws
8150/-.....-2.	Cover with hinge and sash lock

Enclosure height

	91 mm 8150/-.....-091-3.1	150 mm 8150/-.....-150-3.1	190 mm 8150/-.....-190-3.1	230 mm 8150/-.....-230-3.1
8150/-0116-0116-....-3.1	*			
8150/-0176-0116-....-3.1	*			
8150/-0176-0176-....-3.1	*			
8150/-0236-0176-....-3.1	*	*		
8150/-0300-0200-....-3.1		*		
8150/-0360-0176-....-3.1	*	*		
8150/-0360-0360-....-3.1	*	*	*	*
8150/-0400-0300-....-3.1		*		*
8150/-0400-0400-....-3.1		*		*
8150/-0550-0360-....-3.1				*
8150/-0600-0400-....-3.1		*		*
8150/-0400-0600-....-3.1		*		*
8150/-0727-0360-....-3.1	*	*	*	
8150/-0600-0600-....-3.1		*		*
8150/-0787-0480-....-3.1				*
	* = available			

Hinge side

	91 mm 8150/-.....-091-3.1	150 mm 8150/-.....-150-3.1	190 mm 8150/-.....-190-3.1	230 mm 8150/-.....-230-3.1
8150/-0300-0200-....-321		*		
8150/-0360-0176-....-321		*		
8150/-0360-0360-....-321		*	*	
8150/-0400-0300-....-321		*		*
8150/-0400-0400-....-321		*		*
8150/-0550-0360-....-321				*
8150/-0600-0400-....-321		*		*
8150/-0400-0600-....-321		*		*
8150/-0727-0360-....-321		*	*	
8150/-0600-0600-....-321		*		*
8150/-0787-0480-....-321				*
	* = available			

Terminal Boxes

Series 8150



Terminal boxes up to 35 mm²

Nominal cross-section [mm ²]	Max. number of terminals																							
	Wago																							
	2.5						4						6						10					
Colour	gr	bl	PE	PE	gr	or	bl	PE	gr	PE	gr	bl	PE	gr	bl	PE	gr	PE	gr	bl	PE	PE		
Number of conductors per terminal	2	2	2	3	2	2	2	2	4	4	3	3	3	2	2	2	3	4	2	2	2	2		
Mounting rails	 12971E00																							
	Number of mounting rails	2001 - 1201	2001 - 1204	2001 - 1207	2001 - 1307	2002 - 1201	2002 - 1202	2002 - 1204	2002 - 1207	2002 - 1401	2002 - 1407	2002 - 1301	2002 - 1304	2002 - 1307	2004 - 1201	2004 - 1204	2004 - 1207	2004 - 1301	2004 - 1407	2006 - 1201	2006 - 1204	2006 - 1207		
8150/-0176-0116-...-3.1	1	17	17	17	17	14	14	14	14	--	--	14	14	14	12	12	12	--	--	--	--	--		
8150/-0116-0116-...-3.1	1	14	14	14	14	11	11	11	11	--	--	11	11	11	9	9	9	--	--	--	--	--		

Note

Specify with order	Order numbers for enclosures with mounting rails and PE or PA rails
Cable glands	Line-up terminals: number and type
Flanges	Number, type and installation side in enclosure
Terminals	can be fitted to order; please indicate the side on which they are to be fitted.
Available enclosure depths	Phoenix; Weidmüller available on request
	91 mm
Terminal boxes fitted with terminals > 35 mm ² up to 300 mm ² on request.	

Table showing the max. number of possible entries of the enclosure using cable glands series 8161

W x H	without flange				Flange	
	A	B	C	D	A/B	C/D
176 x 116						
M16 x 1.5	6	6	12	12	-	-
M20 x 1.5	4	4	8	8	-	-
M25 x 1.5	2	2	4	4	-	-
M32 x 1.5	1	1	3	3	-	-
M40 x 1.5	1	1	2	2	-	-
M50 x 1.5	-	-	-	-	-	-
M63 x 1.5	-	-	-	-	-	-

05864E00
D = 91 mm

Dimensional Drawing (All Dimensions in mm) - Subject to Alterations

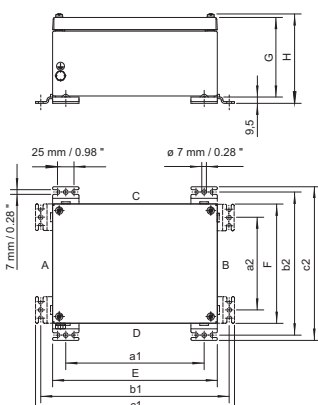

Dimensions in mm	Depth 91 mm	Dimensions in mm	Depth 91 mm
a1	136	a1	76
a2	76	a2	76
b1	212	b1	152
b2	152	b2	152
c1	228	c1	168
c2	168	c2	168
E	176,5	E	116,5
F	116,5	F	116,5
G	91	G	91
H	106	H	106

12648E00

Typ 8150/-0176-0116-091-..1. Typ 8150/-0116-0116-...-3.1

Terminal Boxes

Series 8150

Terminal boxes up to 35 mm²

Nominal cross-section [mm ²]	Max. number of terminals																					
	Wago																					
	2.5				4				6				10									
Colour	gr	bl	PE	PE	gr	or	bl	PE	gr	PE	gr	bl	PE	gr	bl	PE	gr	PE				
Number of conductors per terminal	2	2	2	3	2	2	2	2	4	4	3	3	3	2	2	2	3	4				
Mounting rails	 12970E00																					
8150/-0176-0176-...-3.1	1	23	23	23	23	19	19	19	19	19	19	19	19	19	16	16	16	16	16	13	13	13

Note

Specify with order	Order numbers for enclosures with mounting rails and PE or PA rails
Cable glands	Line-up terminals: number and type
Flanges	Number, type and installation side in enclosure
Terminals	can be fitted to order; please indicate the side on which they are to be fitted.
Available enclosure depths	Phoenix; Weidmüller available on request
Terminal boxes fitted with terminals > 35 mm ² up to 300 mm ² on request.	91 mm

Table showing the max. number of possible entries of the enclosure using cable glands series 8161

W x H	without flange				Flange	
	A	B	C	D	A/B	C/D
176 x 176						
M16 x 1.5	11	11	12	12	-	-
M20 x 1.5	8	8	8	8	-	-
M25 x 1.5	4	4	4	4	-	-
M32 x 1.5	3	3	3	3	-	-
M40 x 1.5	2	2	2	2	-	-
M50 x 1.5	-	-	-	-	-	-
M63 x 1.5	-	-	-	-	-	-

D = 91 mm

Dimensional Drawing (All Dimensions in mm) - Subject to Alterations

Dimensions in mm	Depth
	91 mm
a1	136
a2	136
b1	212
b2	212
c1	228
c2	228
E	176.5
F	176.5
G	91
H	106

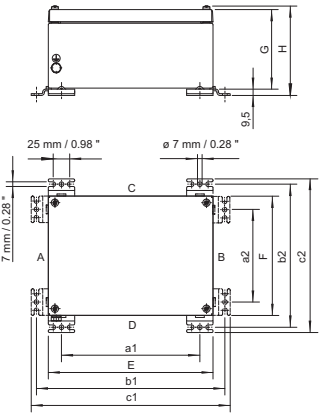

12648E00

Type 8150/-0176-0176-091-...1.

Terminal Boxes

Series 8150



Terminal boxes up to 35 mm²

Nominal cross-section [mm ²]	Max. number of terminals																				
	Wago																				
Colour	2.5			4						6			10								
Number of conductors per terminal	gr	bl	PE	PE	gr	or	bl	PE	gr	PE	gr	bl	PE	gr	bl	PE					
2	2	2	2	3	2	2	2	2	4	4	3	3	3	2	2	2					
3																					
4																					
6																					
10																					
8150/-0236-0176-...-3.1	1	37	37	37	37	27	27	27	27	27	27	27	27	23	23	23	23	23	21	21	21

Note

Specify with order	Order numbers for enclosures with mounting rails and PE or PA rails
Cable glands	Line-up terminals: number and type
Flanges	Number, type and installation side in enclosure
Terminals	can be fitted to order; please indicate the side on which they are to be fitted.
Available enclosure depths	Phoenix; Weidmüller available on request
Terminal boxes fitted with terminals > 35 mm ² up to 300 mm ² on request.	91 mm; 150 mm

Table showing the max. number of possible entries of the enclosure using cable glands series 8161

W x H	without flange				Flange		W x H	without flange				Flange	
	A	B	C	D	A/B	C/D		A	B	C	D	A/B	C/D
236 x 176							236 x 176						
M16 x 1.5	11	11	15	15	-	4	M16 x 1.5	28	28	41	41	9	17
M20 x 1.5	8	8	12	12	-	4	M20 x 1.5	17	17	26	26	6	10
M25 x 1.5	4	4	6	6	-	2	M25 x 1.5	10	10	16	16	4	7
M32 x 1.5	3	3	4	4	-	-	M32 x 1.5	6	6	10	10	2	5
M40 x 1.5	2	2	3	3	-	-	M40 x 1.5	4	4	6	6	1	3
M50 x 1.5	-	-	-	-	-	-	M50 x 1.5	3	3	4	4	1	2
M63 x 1.5	-	-	-	-	-	-	M63 x 1.5	2	2	2	2	-	2

Dimensional Drawing (All Dimensions in mm) - Subject to Alterations

Dimensions in mm	Depth	
	91 mm	150 mm
a1	196	196
a2	136	136
b1	272	272
b2	212	212
c1	288	288
c2	228	228
E	236.5	236.5
F	176.5	176.5
G	91	150
H	106	165



12648E00

Type 8150/-0236-0176-091...1. and 8150/-0236-0176-150...1.

Terminal Boxes

Series 8150

Terminal boxes up to 35 mm²

Nominal cross-section [mm ²]	Max. number of terminals																					
	Wago																					
	2.5				4				6				10									
Colour	gr	bl	PE	PE	gr	or	bl	PE	gr	PE	gr	bl	PE	gr	bl	PE	gr	bl	PE			
Number of conductors per terminal	2	2	2	3	2	2	2	2	4	4	3	3	3	2	2	2	3	4	2	2	2	
Mounting rails	Number of mounting rails																					
	12968E00																					
	12967E00																					
8150/-0300-0200-...-3.1	1	54	54	54	54	43	43	43	43	43	43	43	43	43	36	36	36	36	36	30	30	30
8150/-0300-0200-...-3.1	2	108	108	108	--	86	86	86	86	--	--	--	--	--	72	72	72	--	--	--	--	--

Note

Specify with order	Order numbers for enclosures with mounting rails and PE or PA rails
Cable glands	Line-up terminals: number and type
Flanges	Number, type and installation side in enclosure
Terminals	can be fitted to order; please indicate the side on which they are to be fitted.
Available enclosure depths	Phoenix; Weidmüller available on request
Terminal boxes fitted with terminals > 35 mm ² up to 300 mm ² on request.	150 mm

Table showing the max. number of possible entries of the enclosure using cable glands series 8161

	W x H	without flange				Flange	
		A	B	C	D	A/B	C/D
D = 150 mm	300 x 200						
	M16 x 1.5	33	33	54	54	-	-
	M20 x 1.5	20	20	34	34	-	-
	M25 x 1.5	12	12	21	21	-	-
	M32 x 1.5	7	7	16	16	-	-
	M40 x 1.5	5	5	8	8	-	-
	M50 x 1.5	3	3	5	5	-	-
M63 x 1.5	2	2	3	3	-	-	

Dimensional Drawing (All Dimensions in mm) - Subject to Alterations

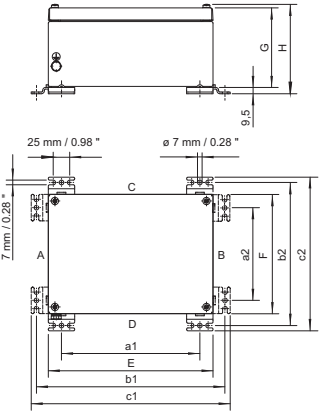

Dimensions in mm	Depth
	150 mm
a1	260
a2	160
b1	336
b2	236
c1	352
c2	252
E	300
F	200
G	150
H	165

12648E00

Type 8150/-0300-0200-150-..1.

Terminal Boxes

Series 8150

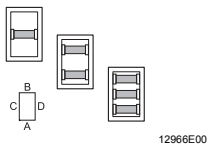

Terminal boxes up to 35 mm²

Nominal cross-section [mm ²]	Max. number of terminals												Wago									
	2.5				4				6				10									
	gr	bl	PE	PE	gr	or	bl	PE	gr	PE	gr	bl	PE	gr	bl	PE	gr	PE	gr	bl	PE	
Colour	gr	bl	PE	PE	gr	or	bl	PE	gr	PE	gr	bl	PE	gr	bl	PE	gr	PE	gr	bl	PE	
Number of conductors per terminal	2	2	2	3	2	2	2	2	4	4	3	3	3	2	2	2	3	4	2	2	2	
Mounting rails																						
	Number of mounting rails	2001 - 1201	2001 - 1204	2001 - 1207	2001 - 1307	2002 - 1201	2002 - 1202	2002 - 1204	2002 - 1207	2002 - 1401	2002 - 1407	2002 - 1301	2002 - 1304	2002 - 1307	2004 - 1201	2004 - 1204	2004 - 1207	2004 - 1301	2004 - 1407	2006 - 1201	2006 - 1204	2006 - 1207
8150/-0300-0200-...-3.1	1	30	30	30	30	24	24	24	24	24	24	24	24	24	20	20	20	20	20	17	17	17
8150/-0300-0200-...-3.1	2	60	60	60	60	48	48	48	48	48	48	48	48	48	40	40	40	40	40	34	34	34
8150/-0300-0200-...-3.1	3	90	90	90	--	72	72	72	72	--	--	--	--	--	--	--	--	--	--	--	--	--

Note

Specify with order	Order numbers for enclosures with mounting rails and PE or PA rails
Cable glands	Line-up terminals: number and type
Flanges	Number, type and installation side in enclosure
Terminals	can be fitted to order; please indicate the side on which they are to be fitted.
Available enclosure depths	Phoenix; Weidmüller available on request
Terminal boxes fitted with terminals > 35 mm ² up to 300 mm ² on request.	150 mm

Table showing the max. number of possible entries of the enclosure using cable glands series 8161

W x H	without flange				Flange	
	A	B	C	D	A/B	C/D
300 x 200						
M16 x 1.5	33	33	54	54	9	-
M20 x 1.5	20	20	34	34	6	-
M25 x 1.5	12	12	21	21	4	-
M32 x 1.5	7	7	16	16	2	-
M40 x 1.5	5	5	8	8	1	-
M50 x 1.5	3	3	5	5	1	-
M63 x 1.5	2	2	3	3	-	-



D = 150 mm

E3

Terminal Boxes

Series 8150

Dimensional Drawing (All Dimensions in mm) - Subject to Alterations

Dimensions in mm	Depth
	150 mm
a1	260
a2	160
b1	336
b2	236
c1	352
c2	252
E	300
F	200
G	150
H	165

12648E00

Type
8150/-0300-0200-150...1.
8150/-0200-0300-150...2.*

* with hinge or sash lock

Terminal boxes up to 35 mm²

	Max. number of terminals																		
	Wago																		
Nominal cross-section [mm ²]	2.5				4				6				10						
Colour	gr	bl	PE	PE	gr	or	bl	PE	gr	PE	gr	bl	PE	gr	bl	PE	gr	PE	
Number of conductors per terminal	2	2	2	3	2	2	2	2	4	4	3	3	3	2	2	2	3	4	
Mounting rails																			
	Number of mounting rails																		
		2001 - 1201	2001 - 1204	2001 - 1207	2001 - 1307	2002 - 1201	2002 - 1202	2002 - 1204	2002 - 1207	2002 - 1401	2002 - 1407	2002 - 1301	2002 - 1304	2002 - 1307	2004 - 1201	2004 - 1204	2004 - 1207	2004 - 1301	2004 - 1407
8150/-0360-0176-...-3.1	1	64	64	64	64	52	52	52	52	52	52	52	52	52	43	43	43	43	43

Note

Specify with order	Order numbers for enclosures with mounting rails and PE or PA rails
Cable glands	Line-up terminals: number and type
Flanges	Number, type and installation side in enclosure
Terminals	can be fitted to order; please indicate the side on which they are to be fitted.
Available enclosure depths	Phoenix; Weidmüller available on request
	91 mm; 150 mm
Terminal boxes fitted with terminals > 35 mm ² up to 300 mm ² on request.	

Table showing the max. number of possible entries of the enclosure using cable glands series 8161

D = 91 mm	W x H	without flange				Flange		D = 150 mm	W x H	without flange				Flange	
		A	B	C	D	A/B	C/D			A	B	C	D	A/B	C/D
	360 x 176								360 x 176						
	M16 x 1.5	11	11	27	27	-	9		M16 x 1.5	28	28	67	67	9	28
	M20 x 1.5	8	8	20	20	-	6		M20 x 1.5	17	17	42	42	6	18
	M25 x 1.5	4	4	10	10	-	6		M25 x 1.5	10	10	26	26	4	13
	M32 x 1.5	3	3	7	7	-	-		M32 x 1.5	6	6	19	19	2	9
	M40 x 1.5	2	2	5	5	-	-		M40 x 1.5	4	4	10	10	1	5
	M50 x 1.5	-	-	-	-	-	-		M50 x 1.5	3	3	6	6	1	3
	M63 x 1.5	-	-	-	-	-	-		M63 x 1.5	2	2	4	4	-	3

Terminal Boxes

Series 8150

Dimensional Drawing (All Dimensions in mm) - Subject to Alterations

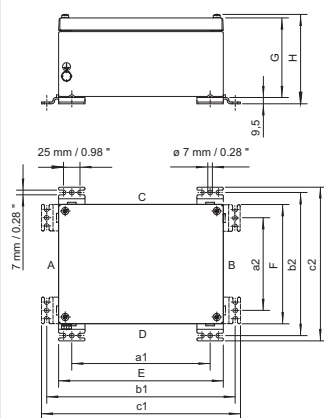

Dimensions in mm	Depth	
	91 mm	150 mm
a1	320	320
a2	136	136
b1	396	396
b2	212	212
c1	412	412
c2	228	228
E	360	360
F	176.5	176.5
G	91	150
H	106	165

12648E00

Type 8150/-0360-0176-091...1. and 8150/-0360-0176-150...1.

Terminal boxes up to 35 mm²

Nominal cross-section [mm ²]	Max. number of terminals																	
	Wago						Phoenix						Weidmüller					
Colour	gr	bl	PE	PE	gr	or	bl	PE	gr	PE	gr	bl	PE	gr	bl	PE	gr	PE
2.5	2	2	2	3	2	2	2	2	4	4	3	3	3	2	2	2	3	4
4																		
6																		
10																		
Number of conductors per terminal	2	2	2	3	2	2	2	2	4	4	3	3	3	2	2	2	3	4
Mounting rails																		
	Number of mounting rails																	
	2001 - 1201	2001 - 1204	2001 - 1207	2001 - 1307	2002 - 1201	2002 - 1202	2002 - 1204	2002 - 1207	2002 - 1401	2002 - 1407	2002 - 1301	2002 - 1304	2002 - 1307	2004 - 1201	2004 - 1204	2004 - 1207	2004 - 1301	2004 - 1407
8150/-0360-0176-...-3.1	1	23	23	23	19	19	19	19	19	19	19	19	19	16	16	16	16	16
8150/-0360-0176-...-3.1	2	46	46	46	38	38	38	38	38	38	38	38	38	32	32	32	32	32
8150/-0360-0176-...-3.1	3	69	69	69	57	57	57	57	57	57	57	57	57	48	48	48	48	--

Note

Specify with order	Order numbers for enclosures with mounting rails and PE or PA rails
Cable glands	Line-up terminals: number and type
Flanges	Number, type and installation side in enclosure
Terminals	can be fitted to order; please indicate the side on which they are to be fitted.
Available enclosure depths	Phoenix; Weidmüller available on request
	91 mm; 150 mm
Terminal boxes fitted with terminals > 35 mm ² up to 300 mm ² on request.	

Table showing the max. number of possible entries of the enclosure using cable glands series 8161

W x H	without flange				Flange		W x H	without flange				Flange	
	A	B	C	D	A/B	C/D		A	B	C	D	A/B	C/D
360 x 176							360 x 176						
M16 x 1.5	11	11	27	27	-	9	M16 x 1.5	28	28	67	67	9	28
M20 x 1.5	8	8	20	20	-	6	M20 x 1.5	17	17	42	42	6	18
M25 x 1.5	4	4	10	10	-	6	M25 x 1.5	10	10	26	26	4	13
M32 x 1.5	3	3	7	7	-	-	M32 x 1.5	6	6	19	19	2	9
M40 x 1.5	2	2	5	5	-	-	M40 x 1.5	4	4	10	10	1	5
M50 x 1.5	-	-	-	-	-	-	M50 x 1.5	3	3	6	6	1	3
M63 x 1.5	-	-	-	-	-	-	M63 x 1.5	2	2	4	4	-	3

Terminal Boxes

Series 8150

Dimensional Drawing (All Dimensions in mm) - Subject to Alterations

Dimensions in mm	Depth	
	91 mm	150 mm
a1	320	320
a2	136	136
b1	396	396
b2	212	212
c1	412	412
c2	228	228
E	360	360
F	176.5	176.5
G	91	150
H	106	165

12648E00

Type
8150/-0360-0176-091...1. and 8150/-0360-0176-150...1.
8150/-0176-0360-150...2.*

* with hinge or sash lock

Terminal boxes up to 35 mm²

	Max. number of terminals																						
	Wago																						
Nominal cross-section [mm ²]	2.5			4						6						10							
Colour	gr	bl	PE	PE	gr	or	bl	PE	gr	PE	gr	bl	PE	gr	bl	PE	gr	PE					
Number of conductors per terminal	2	2	2	3	2	2	2	2	4	4	3	3	3	2	2	2	3	4	2	2	2		
Mounting rails																							
	Number of mounting rails	2001 - 1201	2001 - 1204	2001 - 1207	2001 - 1307	2002 - 1201	2002 - 1202	2002 - 1204	2002 - 1207	2002 - 1401	2002 - 1407	2002 - 1301	2002 - 1304	2002 - 1307	2004 - 1201	2004 - 1204	2004 - 1207	2004 - 1301	2004 - 1407	2006 - 1201	2006 - 1204	2006 - 1207	
8150/-0360-0360-...-3.1	1	64	64	64	64	52	52	52	52	52	52	52	52	52	43	43	43	43	43	36	36	36	
8150/-0360-0360-...-3.1	2	128	128	128	128	104	104	104	104	104	104	104	104	104	86	86	86	86	86	72	72	72	
8150/-0360-0360-...-3.1	3	192	192	192	192	156	156	--	--	--	--	156	156	156	129	129	129	129	129	--	108	108	108

Note

Specify with order	Order numbers for enclosures with mounting rails and PE or PA rails
Cable glands	Line-up terminals: number and type
Flanges	Number, type and installation side in enclosure
Terminals	can be fitted to order; please indicate the side on which they are to be fitted.
Available enclosure depths	Phoenix; Weidmüller available on request
Terminal boxes fitted with terminals > 35 mm ² up to 300 mm ² on request.	91 mm; 150 mm; 190 mm

Terminal Boxes

Series 8150



Table showing the max. number of possible entries of the enclosure using cable glands series 8161

W x H	without flange				Flange		W x H	without flange				Flange	
	A	B	C	D	A/B	C/D		A	B	C	D	A/B	C/D
360 x 360							360 x 360						
M16 x 1.5	27	27	28	28	-	9	M16 x 1.5	65	65	67	67	28	28
M20 x 1.5	20	20	20	20	-	6	M20 x 1.5	42	42	42	42	18	18
M25 x 1.5	10	10	10	10	-	6	M25 x 1.5	26	26	26	26	13	13
M32 x 1.5	7	7	7	7	-	-	M32 x 1.5	18	18	19	19	9	9
M40 x 1.5	5	5	5	5	-	-	M40 x 1.5	10	10	10	10	5	5
M50 x 1.5	-	-	-	-	-	-	M50 x 1.5	6	6	6	6	3	3
M63 x 1.5	-	-	-	-	-	-	M63 x 1.5	4	4	4	4	3	3

W x H	without flange				Flange		W x H	without flange				Flange	
	A	B	C	D	A/B	C/D		A	B	C	D	A/B	C/D
360 x 360							360 x 360						
M16 x 1.5					-	-	M16 x 1.5					-	-
M20 x 1.5	a	a	a	a	-	-	M20 x 1.5	a	a	a	a	-	-
M25 x 1.5					-	-	M25 x 1.5					-	-
M32 x 1.5					-	-	M32 x 1.5					-	-
M40 x 1.5					-	-	M40 x 1.5					-	-
M50 x 1.5	-	-	-	-	-	-	M50 x 1.5	-	-	-	-	-	-
M63 x 1.5	-	-	-	-	-	-	M63 x 1.5	-	-	-	-	-	-

A = on request

E3

Dimensional Drawing (All Dimensions in mm) - Subject to Alterations

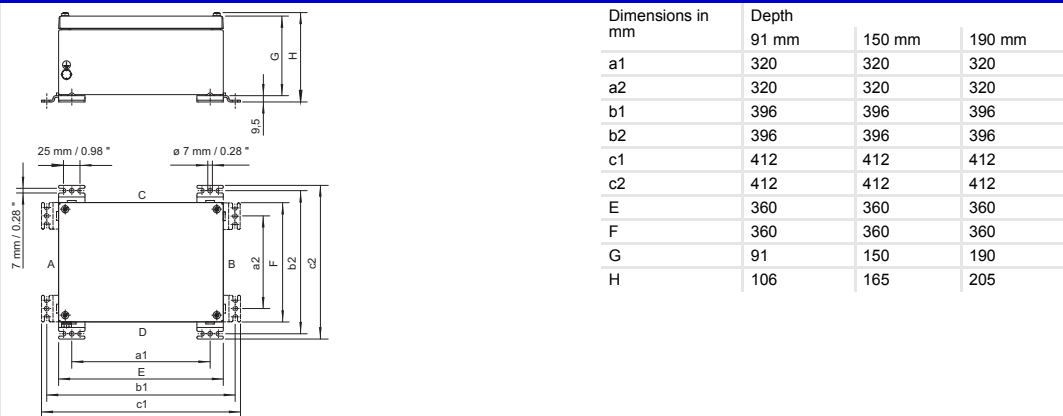

Type
 8150/-0360-0360-091-..1., 8150/-0360-0360-150-..1. and 8150/-0360-0360-190-..1.
 8150/-0360-0360-091-..2.*, 8150/-0360-0360-150-..2.* and 8150/-0360-0360-190-..2.*

* with hinge or sash lock

Terminal boxes up to 35 mm²

Nominal cross-section [mm²]	Max. number of terminals																					
	Wago																					
	2.5				4				6				10									
Colour	gr	bl	PE	PE	gr	or	bl	PE	gr	PE	gr	bl	PE	gr	bl	PE	gr	PE	gr	bl	PE	
Number of conductors per terminal	2	2	2	3	2	2	2	2	4	4	3	3	3	2	2	2	3	4	2	2	2	
Mounting rails																						
	Number of mounting rails	2001 - 1201	2001 - 1204	2001 - 1207	2001 - 1307	2002 - 1201	2002 - 1202	2002 - 1204	2002 - 1207	2002 - 1401	2002 - 1407	2002 - 1301	2002 - 1304	2002 - 1307	2004 - 1201	2004 - 1204	2004 - 1207	2004 - 1301	2004 - 1407	2006 - 1201	2006 - 1204	2006 - 1207
8150/-0400-0300-....-3.1	1	78	78	78	78	63	63	63	63	63	63	63	63	63	52	52	52	52	52	43	43	43
8150/-0400-0300-....-3.1	2	156	156	156	156	126	126	126	126	126	126	126	126	126	104	104	104	104	104	86	86	86
8150/-0400-0300-....-3.1	3	234	234	234	--	189	189	189	189	--	--	--	--	--	--	--	--	--	--	--	--	--

Terminal Boxes

Series 8150

Note

	Order numbers for enclosures with mounting rails and PE or PA rails
Specify with order	Line-up terminals: number and type
Cable glands	Number, type and installation side in enclosure
Flanges	can be fitted to order; please indicate the side on which they are to be fitted.
Terminals	Phoenix; Weidmüller available on request
Available enclosure depths	150 mm; 230 mm
Terminal boxes fitted with terminals > 35 mm ² up to 300 mm ² on request.	

Table showing the max. number of possible entries of the enclosure using cable glands series 8161

Cable gland 05864E00	W x H	without flange				Flange		W x H	without flange				Flange	
		A	B	C	D	A/B	C/D		A	B	C	D	A/B	C/D
D = 150 mm	400 x 300							400 x 300						
	M16 x 1.5	54	54	74	74		28	M16 x 1.5	91	91	123	123		69
	M20 x 1.5	34	34	48	48	a	18	M20 x 1.5	59	59	85	85	a	44
	M25 x 1.5	21	21	30	30		13	M25 x 1.5	43	43	60	60		28
	M32 x 1.5	16	16	22	22	9	M32 x 1.5	27	27	39	39	20		
	M40 x 1.5	8	8	11	11	5	M40 x 1.5	15	15	22	22	10		
	M50 x 1.5	5	5	7	7	3	M50 x 1.5	9	9	14	14	8		
	M63 x 1.5	3	3	5	5	3	M63 x 1.5	6	6	9	9	6		

A = on request

Dimensional Drawing (All Dimensions in mm) - Subject to Alterations

Dimensions in mm	Depth			
	150 mm	230 mm	150 mm*	230 mm*
a1	360	360	360	360
a2	260	260	260	260
b1	436	436	436	436
b2	336	336	336	336
c1	452	452	452	452
c2	352	352	352	352
E	400	400	400	400
F	300	300	300	300
G	150	230	150	230
H	165	244.8	163.5	243.5

12648E00

Type
8150/-0400-0300-150...1. and 8150/-0400-0300-230...1.
8150/-0400-0300-150...2. and 8150/-0400-0300-230...2.*

* with hinge or sash lock

Terminal boxes up to 35 mm²

	Max. number of terminals																				
	Wago																				
Nominal cross-section [mm ²]	2.5				4				6				10								
Colour	gr	bl	PE	PE	gr	or	bl	PE	gr	PE	gr	bl	PE	gr	bl	PE	gr	PE			
Number of conductors per terminal	2	2	2	3	2	2	2	2	4	4	3	3	3	2	2	2	3	4	2	2	2
Mounting rails	Number of mounting rails																				
	2001 - 1201	2001 - 1204	2001 - 1207	2001 - 1307	2002 - 1201	2002 - 1202	2002 - 1204	2002 - 1207	2002 - 1401	2002 - 1407	2002 - 1301	2002 - 1304	2002 - 1307	2004 - 1201	2004 - 1204	2004 - 1207	2004 - 1301	2004 - 1407	2006 - 1201	2006 - 1204	2006 - 1207
8150/-0400-0300-...-3.1	1	54	54	54	54	43	43	43	43	43	43	43	43	36	36	36	36	36	30	30	30
8150/-0400-0300-...-3.1	2	108	108	108	108	86	86	86	86	86	86	86	86	72	72	72	72	72	60	60	60
8150/-0400-0300-...-3.1	3	162	162	162	162	129	129	129	129	129	129	129	129	108	108	108	108	108	90	90	90
8150/-0400-0300-...-3.1	4	216	216	216	--	172	172	172	172	--	--	--	--	--	--	--	--	--	--	--	--

Terminal Boxes

Series 8150



Note

	Order numbers for enclosures with mounting rails and PE or PA rails
Specify with order	Line-up terminals: number and type
Cable glands	Number, type and installation side in enclosure
Flanges	can be fitted to order; please indicate the side on which they are to be fitted.
Terminals	Phoenix; Weidmüller available on request
Available enclosure depths	150 mm; 230 mm

Terminal boxes fitted with terminals > 35 mm² up to 300 mm² on request.

Table showing the max. number of possible entries of the enclosure using cable glands series 8161

W x H	without flange				Flange		W x H	without flange				Flange	
	A	B	C	D	A/B	C/D		A	B	C	D	A/B	C/D
400 x 300							400 x 300						
M16 x 1.5	54	54	74	74		28	M16 x 1.5	91	91	123	123		69
M20 x 1.5	34	34	48	48	a	18	M20 x 1.5	59	59	85	85	a	44
M25 x 1.5	21	21	30	30		13	M25 x 1.5	43	43	60	60		28
M32 x 1.5	16	16	22	22		9	M32 x 1.5	27	27	39	39		20
M40 x 1.5	8	8	11	11		5	M40 x 1.5	15	15	22	22		10
M50 x 1.5	5	5	7	7		3	M50 x 1.5	9	9	14	14		8
M63 x 1.5	3	3	5	5		3	M63 x 1.5	6	6	9	9		6

D = 150 mm D = 230 mm
A = on request

E3

Dimensional Drawing (All Dimensions in mm) - Subject to Alterations

Dimensions in mm	Depth			
	150 mm	230 mm	150 mm*	230 mm*
a1	360	360	360	360
a2	260	260	260	260
b1	436	436	436	436
b2	336	336	336	336
c1	452	452	452	452
c2	352	352	352	352
E	400	400	400	400
F	300	300	300	300
G	150	230	150	230
H	165	244.8	163.5	243.5

12648E00

Type
8150/..-0400-0300-150-..1. and 8150/..-0400-0300-230-..1.
8150/..-0400-0300-150-..2. and 8150/..-0400-0300-230-..2.*

* with hinge or sash lock

Terminal boxes up to 35 mm²

	Max. number of terminals																																							
	Wago																																							
	2.5				4				6				10																											
Nominal cross-section [mm ²]	gr	bl	PE	PE	gr	or	bl	PE	gr	PE	gr	bl	PE	gr	bl	PE	gr	PE																						
Colour	2	2	2	3	2	2	2	2	4	4	3	3	3	2	2	2	3	4																						
Number of conductors per terminal	2	2	2	3	2	2	2	2	4	4	3	3	3	2	2	2	3	4																						
Mounting rails																																								
	<table border="1"> <thead> <tr> <th>Number of mounting rails</th> <th>2001 - 1201</th><th>2001 - 1204</th><th>2001 - 1207</th><th>2001 - 1307</th> <th>2002 - 1201</th><th>2002 - 1202</th><th>2002 - 1204</th><th>2002 - 1207</th> <th>2002 - 1401</th><th>2002 - 1407</th><th>2002 - 1301</th><th>2002 - 1304</th><th>2002 - 1307</th> <th>2004 - 1201</th><th>2004 - 1204</th><th>2004 - 1207</th><th>2004 - 1301</th><th>2004 - 1407</th> <th>2006 - 1201</th><th>2006 - 1204</th><th>2006 - 1207</th> </tr> </thead> </table>																		Number of mounting rails	2001 - 1201	2001 - 1204	2001 - 1207	2001 - 1307	2002 - 1201	2002 - 1202	2002 - 1204	2002 - 1207	2002 - 1401	2002 - 1407	2002 - 1301	2002 - 1304	2002 - 1307	2004 - 1201	2004 - 1204	2004 - 1207	2004 - 1301	2004 - 1407	2006 - 1201	2006 - 1204	2006 - 1207
Number of mounting rails	2001 - 1201	2001 - 1204	2001 - 1207	2001 - 1307	2002 - 1201	2002 - 1202	2002 - 1204	2002 - 1207	2002 - 1401	2002 - 1407	2002 - 1301	2002 - 1304	2002 - 1307	2004 - 1201	2004 - 1204	2004 - 1207	2004 - 1301	2004 - 1407	2006 - 1201	2006 - 1204	2006 - 1207																			
8150/..-0400-0400-...-3.1	1	78	78	78	78	63	63	63	63	63	63	63	63	63	52	52	52	52	52	43	43	43																		
8150/..-0400-0400-...-3.1	2	156	156	156	156	126	126	126	126	126	126	126	126	126	104	104	104	104	104	86	86	86																		
8150/..-0400-0400-...-3.1	3	234	234	234	234	189	189	189	189	189	189	189	189	189	156	156	156	156	156	129	129	129																		
8150/..-0400-0400-...-3.1	4	312	312	312	--	252	252	252	252	--	--	--	--	--	--	--	--	--	--	--	--	--																		

Terminal Boxes

Series 8150

Note

	Order numbers for enclosures with mounting rails and PE or PA rails
Specify with order	Line-up terminals: number and type
Cable glands	Number, type and installation side in enclosure
Flanges	can be fitted to order; please indicate the side on which they are to be fitted.
Terminals	Phoenix; Weidmüller available on request
Available enclosure depths	150 mm; 230 mm

Terminal boxes fitted with terminals > 35 mm² up to 300 mm² on request.

Table showing the max. number of possible entries of the enclosure using cable glands series 8161

Cable Gland 05864E00	W x H	without flange				Flange		W x H	without flange				Flange	
		A	B	C	D	A/B	C/D		A	B	C	D	A/B	C/D
D = 150 mm	400 x 400							400 x 400						
	M16 x 1.5	74	74	74	74	28	28	M16 x 1.5	123	123	123	123	69	69
	M20 x 1.5	48	48	48	48	18	18	M20 x 1.5	85	85	85	85	44	44
	M25 x 1.5	29	29	30	30	13	13	M25 x 1.5	59	59	60	60	28	28
	M32 x 1.5	21	21	22	22	9	9	M32 x 1.5	38	38	39	39	20	20
	M40 x 1.5	11	11	11	11	5	5	M40 x 1.5	22	22	22	22	10	10
	M50 x 1.5	7	7	7	7	3	3	M50 x 1.5	14	14	14	14	8	8
M63 x 1.5	5	5	5	5	3	3	M63 x 1.5	9	9	9	9	6	6	
D = 230 mm	400 x 400							400 x 400						
	M16 x 1.5	123	123	123	123	69	69	M16 x 1.5	123	123	123	123	69	69
	M20 x 1.5	85	85	85	85	44	44	M20 x 1.5	85	85	85	85	44	44
	M25 x 1.5	59	59	60	60	28	28	M25 x 1.5	59	59	60	60	28	28
	M32 x 1.5	38	38	39	39	20	20	M32 x 1.5	38	38	39	39	20	20
	M40 x 1.5	22	22	22	22	10	10	M40 x 1.5	22	22	22	22	10	10
	M50 x 1.5	14	14	14	14	8	8	M50 x 1.5	14	14	14	14	8	8
M63 x 1.5	9	9	9	9	6	6	M63 x 1.5	9	9	9	9	6	6	

Dimensional Drawing (All Dimensions in mm) - Subject to Alterations

12648E00

Dimensions in mm	Depth			
	150 mm	230 mm	150 mm*	230 mm*
a1	360	360	360	360
a2	360	360	360	360
b1	436	436	436	436
b2	436	436	436	436
c1	452	452	452	452
c2	452	452	452	452
E	400	400	400	400
F	400	400	400	400
G	150	230	150	230
H	165	245	163.5	243.5

Type
8150/-0400-0400-150-..1. and 8150/-0400-0400-230-..1.
8150/-0400-0400-150-..2. and 8150/-0400-0400-230-..2.*

* with hinge or sash lock

Terminal Boxes

Series 8150

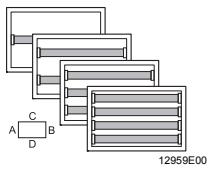

Terminal boxes up to 35 mm²

Nominal cross-section [mm ²]	Max. number of terminals																							
	Wago																							
	2.5						4						6						10					
Colour	gr	bl	PE	PE	gr	or	bl	PE	gr	PE	gr	bl	PE	gr	bl	PE	gr	PE	gr	bl	PE	PE		
Number of conductors per terminal	2	2	2	3	2	2	2	2	4	4	3	3	3	2	2	2	3	4	2	2	2	2		
Mounting rails																								
	Number of mounting rails	2001 - 1201	2001 - 1204	2001 - 1207	2001 - 1307	2002 - 1201	2002 - 1202	2002 - 1204	2002 - 1207	2002 - 1401	2002 - 1407	2002 - 1301	2002 - 1304	2002 - 1307	2004 - 1201	2004 - 1204	2004 - 1207	2004 - 1301	2004 - 1407	2006 - 1201	2006 - 1204	2006 - 1207		
8150/-0550-0360-...-3.1	1	113	113	113	113	91	91	91	91	91	91	91	91	91	77	77	77	77	77	63	63	63		
8150/-0550-0360-...-3.1	2	226	226	226	226	182	182	182	182	182	182	182	182	182	154	154	154	154	154	126	126	126		
8150/-0550-0360-...-3.1	3	339	339	339	339	273	273	273	273	273	273	273	273	273	231	231	231	231	--	189	189	189		
8150/-0550-0360-...-3.1	4	452	452	452	--	364	364	364	364	--	--	--	--	--	--	--	--	--	--	--	--	--		

Note

Specify with order	Order numbers for enclosures with mounting rails and PE or PA rails
Cable glands	Line-up terminals: number and type
Flanges	Number, type and installation side in enclosure
Terminals	can be fitted to order; please indicate the side on which they are to be fitted.
Available enclosure depths	Phoenix; Weidmüller available on request
Terminal boxes fitted with terminals > 35 mm ² up to 300 mm ² on request.	230 mm

Table showing the max. number of possible entries of the enclosure using cable glands series 8161

W x H	without flange				Flange	
	A	B	C	D	A/B	C/D
550 x 360						
M16 x 1.5	91	91	123	123		
M20 x 1.5	59	59	85	85		
M25 x 1.5	43	43	59	59	a	a
M32 x 1.5	27	27	38	38		
M40 x 1.5	15	15	22	22		
M50 x 1.5	9	9	14	14		
M63 x 1.5	6	6	9	9		

D = 230 mm
A = on request

Dimensional Drawing (All Dimensions in mm) - Subject to Alterations

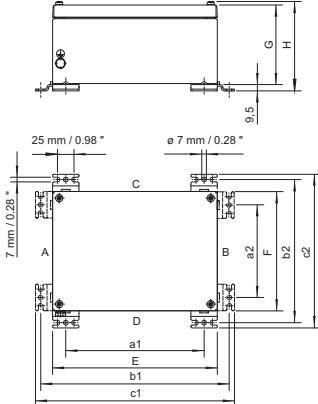

Dimensions in mm	Depth
	230 mm
a1	510
a2	320
b1	586
b2	396
c1	602
c2	412
E	550
F	360
G	230
H	245

12648E00

Type 8150/-0550-0360-230...1.

Terminal Boxes

Series 8150

Terminal boxes up to 35 mm²

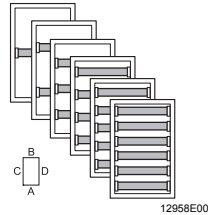
	Max. number of terminals																				
	Wago																				
Nominal cross-section [mm ²]	2.5						4						6						10		
Colour	gr	bl	PE	PE	gr	or	bl	PE	gr	PE	gr	bl	PE	gr	bl	PE	gr	PE	gr	bl	PE
Number of conductors per terminal	2	2	2	3	2	2	2	2	4	4	3	3	3	2	2	2	3	4	2	2	2
Mounting rails	Number of mounting rails																				
																					
8150/-0550-0360-...-3.1	1	64	64	64	64	52	52	52	52	52	52	52	52	43	43	43	43	43	36	36	36
8150/-0550-0360-...-3.1	2	128	128	128	128	104	104	104	104	104	104	104	104	86	86	86	86	86	72	72	72
8150/-0550-0360-...-3.1	3	192	192	192	192	156	156	156	156	156	156	156	156	129	129	129	129	129	108	108	108
8150/-0550-0360-...-3.1	4	256	256	256	256	208	208	208	208	208	208	208	208	172	172	172	172	172	144	144	144
8150/-0550-0360-...-3.1	5	320	320	320	320	260	260	260	260	--	--	260	260	215	215	215	--	--	--	--	--
8150/-0550-0360-...-3.1	6	384	384	384	--	312	312	312	312	--	--	--	--	--	--	--	--	--	--	--	--

Note

Specify with order	Order numbers for enclosures with mounting rails and PE or PA rails
Cable glands	Number, type and installation side in enclosure
Flanges	can be fitted to order; please indicate the side on which they are to be fitted.
Terminals	Phoenix; Weidmüller available on request
Available enclosure depths	230 mm

Terminal boxes fitted with terminals > 35 mm² up to 300 mm² on request.

Table showing the max. number of possible entries of the enclosure using cable glands series 8161

W x H	without flange				Flange	
	A	B	C	D	A/B	C/D
550 x 360						
M16 x 1.5	91	91	123	123		
M20 x 1.5	59	59	85	85		
M25 x 1.5	43	43	59	59	a	a
M32 x 1.5	27	27	38	38		
M40 x 1.5	15	15	22	22		
M50 x 1.5	9	9	14	14		
M63 x 1.5	6	6	9	9		

D = 230 mm
A = on request

Dimensional Drawing (All Dimensions in mm) - Subject to Alterations

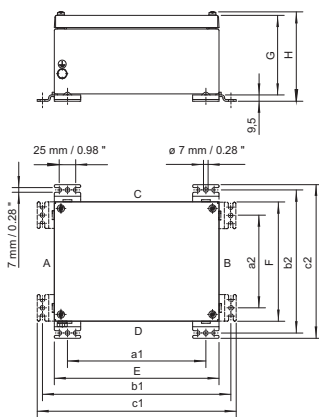

Dimensions in mm	Depth	
	230 mm	230 mm*
a1	510	510
a2	320	320
b1	586	586
b2	396	396
c1	602	602
c2	412	412
E	550	550
F	360	360
G	230	230
H	245	243.5

12648E00

Type
8150/-0550-0360-230...1.
8150/-0360-0550-230...2.*

* with hinge or sash lock

Terminal Boxes

Series 8150



Terminal boxes up to 35 mm²

Nominal cross-section [mm ²]	Max. number of terminals																					
	Wago																					
	2.5				4				6				10									
Colour	gr	bl	PE	PE	gr	or	bl	PE	gr	PE	gr	bl	PE	gr	bl	PE	gr	PE				
Number of conductors per terminal	2	2	2	3	2	2	2	2	4	4	3	3	3	2	2	2	3	4	2	2	2	
Mounting rails	Number of mounting rails																					
	2001 - 1201	2001 - 1204	2001 - 1207	2001 - 1307	2002 - 1201	2002 - 1202	2002 - 1204	2002 - 1207	2002 - 1401	2002 - 1407	2002 - 1301	2002 - 1304	2002 - 1307	2004 - 1201	2004 - 1204	2004 - 1207	2004 - 1301	2004 - 1407	2006 - 1201	2006 - 1204	2006 - 1207	
8150/-0600-0400-...-3.1	1	125	125	125	125	101	101	101	101	101	101	101	101	101	85	85	85	85	85	70	70	70
8150/-0600-0400-...-3.1	2	250	250	250	250	202	202	202	202	202	202	202	202	202	170	170	170	170	170	140	140	140
8150/-0600-0400-...-3.1	3	375	375	375	375	303	303	303	303	303	303	303	303	303	255	255	255	255	255	210	210	210
8150/-0600-0400-...-3.1	4	500	500	500	500	404	404	404	404	--	--	--	--	--	--	--	--	--	--	--	--	--

Note

Specify with order	Order numbers for enclosures with mounting rails and PE or PA rails
Cable glands	Line-up terminals: number and type
Flanges	Number, type and installation side in enclosure
Terminals	can be fitted to order; please indicate the side on which they are to be fitted.
Available enclosure depths	Phoenix; Weidmüller available on request
Terminal boxes fitted with terminals > 35 mm ² up to 300 mm ² on request.	150 mm; 230 mm

Table showing the max. number of possible entries of the enclosure using cable glands series 8161

W x H	without flange				Flange		W x H	without flange				Flange	
	A	B	C	D	A/B	C/D		A	B	C	D	A/B	C/D
600 x 400							600 x 400						
M16 x 1.5	74	74	117	117	28	47	M16 x 1.5	123	123	187	187	69	110
M20 x 1.5	48	48	74	74	18	31	M20 x 1.5	85	85	130	130	44	74
M25 x 1.5	30	30	46	46	13	21	M25 x 1.5	60	60	91	91	28	49
M32 x 1.5	22	22	33	33	9	15	M32 x 1.5	39	39	63	63	20	31
M40 x 1.5	11	11	18	18	5	8	M40 x 1.5	22	22	34	34	10	16
M50 x 1.5	7	7	11	11	3	5	M50 x 1.5	14	14	22	22	8	14
M63 x 1.5	5	5	7	7	3	5	M63 x 1.5	9	9	14	14	6	10

Dimensional Drawing (All Dimensions in mm) - Subject to Alterations

Dimensions in mm	Depth			
	150 mm	230 mm	150 mm*	230 mm*
a1	560	560	560	560
a2	360	360	360	360
b1	636	636	636	636
b2	436	436	436	436
c1	652	652	652	652
c2	452	452	452	452
E	600	600	600	600
F	400	400	400	400
G	150	230	150	230
H	165	245	163.5	243.5

Type
8150/-0600-0400-150-..1. and 8150/-0600-0400-230-..1.
8150/-0600-0400-150-..2. and 8150/-0600-0400-230-..2.*

* with hinge or sash lock

Terminal Boxes

Series 8150

Terminal boxes up to 35 mm²

Nominal cross-section [mm ²]	Max. number of terminals																		
	Wago																		
Colour	2.5				4				6				10						
Number of conductors per terminal	gr	bl	PE	PE	gr	or	bl	PE	gr	PE	gr	bl	PE	gr	bl	PE	gr	bl	PE
8150/-0600-0400-...-3.1	1	78	78	78	78	63	63	63	63	63	63	63	63	63	63	63	63	63	63
8150/-0600-0400-...-3.1	2	156	156	156	156	126	126	126	126	126	126	126	126	126	126	126	126	126	126
8150/-0600-0400-...-3.1	3	234	234	234	234	189	189	189	189	189	189	189	189	189	189	189	189	189	189
8150/-0600-0400-...-3.1	4	312	312	312	312	252	252	252	252	252	252	252	252	252	252	252	252	252	252
8150/-0600-0400-...-3.1	5	390	390	390	390	315	315	315	315	--	--	315	315	315	260	260	260	260	260
8150/-0600-0400-...-3.1	6	468	468	468	--	378	378	378	378	--	--	--	--	--	--	--	--	--	--

Note

Specify with order	Order numbers for enclosures with mounting rails and PE or PA rails
Cable glands	Number, type and installation side in enclosure
Flanges	can be fitted to order; please indicate the side on which they are to be fitted.
Terminals	Phoenix; Weidmüller available on request
Available enclosure depths	150 mm; 230 mm
Terminal boxes fitted with terminals > 35 mm ² up to 300 mm ² on request.	

Table showing the max. number of possible entries of the enclosure using cable glands series 8161

W x H	without flange				Flange		W x H	without flange				Flange	
	A	B	C	D	A/B	C/D		A	B	C	D	A/B	C/D
600 x 400							600 x 400						
M16 x 1.5	74	74	117	117	28	47	M16 x 1.5	123	123	187	187	69	110
M20 x 1.5	48	48	74	74	18	31	M20 x 1.5	85	85	130	130	44	74
M25 x 1.5	30	30	46	46	13	21	M25 x 1.5	60	60	91	91	28	49
M32 x 1.5	22	22	33	33	9	15	M32 x 1.5	39	39	63	63	20	31
M40 x 1.5	11	11	18	18	5	8	M40 x 1.5	22	22	34	34	10	16
M50 x 1.5	7	7	11	11	3	5	M50 x 1.5	14	14	22	22	8	14
M63 x 1.5	5	5	7	7	3	5	M63 x 1.5	9	9	14	14	6	10

Dimensional Drawing (All Dimensions in mm) - Subject to Alterations

Dimensions in mm	Depth			
	150 mm	230 mm	150 mm*	230 mm*
a1	560	560	560	560
a2	360	360	360	360
b1	636	636	636	636
b2	436	436	436	436
c1	652	652	652	652
c2	452	452	452	452
E	600	600	600	600
F	400	400	400	400
G	150	230	150	230
H	165	245	163.5	243.5

Type
 8150/-0600-0400-150-..1. and 8150/-0600-0400-230-..1.
 8150/-0400-0600-150-..2. and 8150/-0400-0600-230-..2.*

* with hinge or sash lock

Terminal Boxes

Series 8150



Terminal boxes up to 35 mm²

Nominal cross-section [mm ²]	Max. number of terminals																							
	Wago																							
Colour	2.5						4						6						10					
Number of conductors per terminal	gr	bl	PE	PE	gr	or	bl	PE	gr	PE	gr	bl	PE	gr	bl	PE	gr	PE	gr	bl	PE	PE		
Mounting rails																								
	2	2	2	3	2	2	2	2	4	4	3	3	3	2	2	2	3	4	2	2	2	2		
	2001 - 1201	2001 - 1204	2001 - 1207	2001 - 1307	2002 - 1201	2002 - 1202	2002 - 1204	2002 - 1207	2002 - 1401	2002 - 1407	2002 - 1301	2002 - 1304	2002 - 1307	2004 - 1201	2004 - 1204	2004 - 1207	2004 - 1301	2004 - 1407	2006 - 1201	2006 - 1204	2006 - 1207	2006 - 1207		
8150/-0727-0360-...-3.1	1	113	113	113	113	91	91	91	91	91	91	91	91	77	77	77	77	77	63	63	63	63		
8150/-0727-0360-...-3.1	2	226	226	226	226	182	182	182	182	182	182	182	182	154	154	154	154	154	126	126	126	126		
8150/-0727-0360-...-3.1	3	339	339	339	339	273	273	273	273	273	273	273	273	231	231	231	231	231	--	189	189	189		
8150/-0727-0360-...-3.1	4	452	452	452	--	364	364	364	364	--	--	--	--	--	--	--	--	--	--	--	--	--		

Note

Specify with order	Order numbers for enclosures with mounting rails and PE or PA rails
Cable glands	Line-up terminals: number and type
Flanges	Number, type and installation side in enclosure
Terminals	can be fitted to order; please indicate the side on which they are to be fitted.
Available enclosure depths	Phoenix; Weidmüller available on request
	150 mm; 230 mm

Terminal boxes fitted with terminals > 35 mm² up to 300 mm² on request.

Table showing the max. number of possible entries of the enclosure using cable glands series 8161

W x H	without flange				Flange	
	A	B	C	D	A/B	C/D
727 x 360						
M16 x 1.5	65	65	117	117		
M20 x 1.5	42	42	74	74		
M25 x 1.5	26	26	46	46	a	a
M32 x 1.5	18	18	33	33		
M40 x 1.5	10	10	36	36		
M50 x 1.5	6	6	22	22		
M63 x 1.5	4	4	14	14		

D = 150 mm
A = on request

Dimensional Drawing (All Dimensions in mm) - Subject to Alterations

	Dimensions in mm	Depth	
			150 mm
	a1		687
	a2		320
	b1		763
	b2		398
	c1		779
	c2		412
	E		727
F		360	
G		150	
H		165	

12648E00

Type 8150/-0727-0360-150...1.

Terminal Boxes

Series 8150

Terminal boxes up to 35 mm²

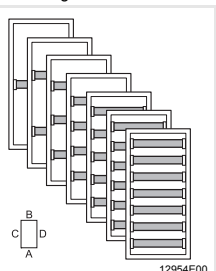
Nominal cross-section [mm ²]	Max. number of terminals																	
	Wago																	
Colour	2.5				4						6						10	
Number of conductors per terminal	gr	bl	PE	PE	gr	or	bl	PE	gr	PE	gr	bl	PE	gr	bl	PE	gr	PE
Mounting rails																		
8150/-0727-0360-...-3.1	1	64	64	64	64	52	52	52	52	52	52	52	52	43	43	43	43	43
8150/-0727-0360-...-3.1	2	128	128	128	128	104	104	104	104	104	104	104	104	86	86	86	86	86
8150/-0727-0360-...-3.1	3	192	192	192	192	156	156	156	156	156	156	156	156	129	129	129	129	129
8150/-0727-0360-...-3.1	4	256	256	256	256	208	208	208	208	208	208	208	208	172	172	172	172	172
8150/-0727-0360-...-3.1	5	320	320	320	320	260	260	260	260	260	260	260	260	215	215	215	215	215
8150/-0727-0360-...-3.1	6	384	384	384	384	312	312	312	312	312	312	312	312	258	258	258	258	--
8150/-0727-0360-...-3.1	7	448	448	448	448	364	364	364	364	--	--	--	--	301	301	301	--	--

Note

Specify with order	Order numbers for enclosures with mounting rails and PE or PA rails
Cable glands	Line-up terminals: number and type
Flanges	Number, type and installation side in enclosure can be fitted to order; please indicate the side on which they are to be fitted.
Terminals	Phoenix; Weidmüller available on request
Available enclosure depths	150 mm; 230 mm
Terminal boxes fitted with terminals > 35 mm ² up to 300 mm ² on request.	

Table showing the max. number of possible entries of the enclosure using cable glands series 8161

W x H	without flange				Flange	
	A	B	C	D	A/B	C/D
727 x 360						
M16 x 1.5	65	65	117	117	a	a
M20 x 1.5	42	42	74	74		
M25 x 1.5	26	26	46	46		
M32 x 1.5	18	18	33	33		
M40 x 1.5	10	10	36	36		
M50 x 1.5	6	6	22	22		
M63 x 1.5	4	4	14	14		

A = on request

Dimensional Drawing (All Dimensions in mm) - Subject to Alterations

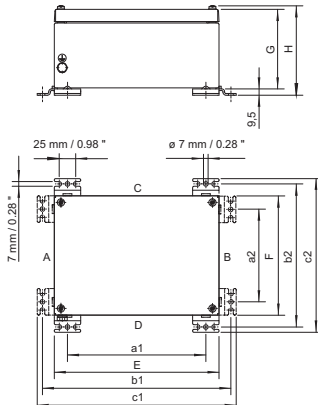

Dimensions in mm	Depth	
	150 mm	150 mm*
a1	687	687
a2	320	320
b1	763	763
b2	398	398
c1	779	779
c2	412	412
E	727	727
F	360	360
G	150	150
H	165	163.5

Type
 8150/-0727-0360-150-1.
 8150/-0360-0727-150-2.*

* with hinge or sash lock

Terminal Boxes

Series 8150



Terminal boxes up to 35 mm²

Nominal cross-section [mm ²]	Max. number of terminals																							
	Wago																							
Colour	2.5				4								6						10					
Number of conductors per terminal	gr	bl	PE	PE	gr	or	bl	PE	gr	PE	gr	bl	PE	gr	bl	PE	gr	PE	gr	bl	PE	gr	bl	PE
2	2	2	2	3	2	2	2	2	4	4	3	3	3	2	2	2	3	4	2	2	2	2	2	
3	3	3	3	3	3	3	3	3	3	3	3	3	3	3	3	3	3	3	3	3	3	3	3	
4	4	4	4	4	4	4	4	4	4	4	4	4	4	4	4	4	4	4	4	4	4	4	4	
5	5	5	5	5	5	5	5	5	--	--	5	5	5	5	5	5	5	5	5	5	5	5	5	
6	6	6	6	--	6	6	6	6	--	--	--	--	--	--	--	--	--	--	--	--	--	--	--	

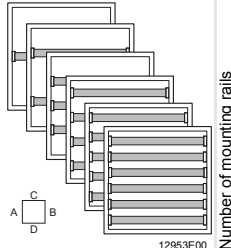

E3

Note

Specify with order	Order numbers for enclosures with mounting rails and PE or PA rails
Cable glands	Line-up terminals: number and type
Flanges	Number, type and installation side in enclosure
Terminals	can be fitted to order; please indicate the side on which they are to be fitted.
Available enclosure depths	Phoenix; Weidmüller available on request
Terminal boxes fitted with terminals > 35 mm ² up to 300 mm ² on request.	150 mm; 230 mm

Table showing the max. number of possible entries of the enclosure using cable glands series 8161

W x H	without flange				Flange		W x H	without flange				Flange	
	A	B	C	D	A/B	C/D		A	B	C	D	A/B	C/D
600 x 600							600 x 600						
M16 x 1.5	116	116	117	117	47	47	M16 x 1.5	187	187	190	190	110	110
M20 x 1.5	73	73	74	74	31	31	M20 x 1.5	130	130	131	131	74	74
M25 x 1.5	45	45	46	46	21	21	M25 x 1.5	91	91	94	94	49	49
M32 x 1.5	33	33	33	33	15	15	M32 x 1.5	63	63	63	63	31	31
M40 x 1.5	18	18	18	18	8	8	M40 x 1.5	34	34	36	36	16	16
M50 x 1.5	11	11	11	11	5	5	M50 x 1.5	22	22	22	22	14	14
M63 x 1.5	7	7	7	7	5	5	M63 x 1.5	14	14	14	14	10	10

Dimensional Drawing (All Dimensions in mm) - Subject to Alterations

Dimensions in mm	Depth			
	150 mm	230 mm	150 mm*	230 mm*
a1	560	560	560	560
a2	560	560	560	560
b1	636	636	636	636
b2	636	636	636	636
c1	652	652	652	652
c2	652	652	652	652
E	600	600	600	600
F	600	600	600	600
G	150	230	150	230
H	165	245	163.5	243.5

Type
8150/-0600-0600-150-..1. and 8150/-0600-0600-230-..1.
8150/-0600-0600-150-..2. and 8150/-0600-0600-230-..2.*

* with hinge or sash lock

Terminal Boxes

Series 8150

Terminal boxes up to 35 mm²

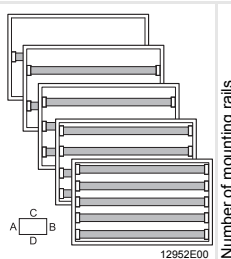
	Max. number of terminals																										
	Wago																										
Nominal cross-section [mm ²]	2.5						4						6						10								
Colour	gr	bl	PE	PE	gr	or	bl	PE	gr	PE	gr	bl	PE	gr	bl	PE	gr	bl	PE								
Number of conductors per terminal	2	2	2	3	2	2	2	2	4	4	3	3	3	2	2	2	3	4	2	2	2	3	4	2	2	2	
Mounting rails																											
	Number of mounting rails	2001 - 1201	2001 - 1204	2001 - 1207	2001 - 1307	2002 - 1201	2002 - 1202	2002 - 1204	2002 - 1207	2002 - 1401	2002 - 1407	2002 - 1301	2002 - 1304	2002 - 1307	2004 - 1201	2004 - 1204	2004 - 1207	2004 - 1301	2004 - 1407	2006 - 1201	2006 - 1204	2006 - 1207					
8150/-0787-0480-...-3.1	1	170	170	170	170	137	137	137	137	137	137	137	137	137	115	115	115	115	115	95	95	95					
8150/-0787-0480-...-3.1	2	340	340	340	340	274	274	274	274	274	274	274	274	274	230	230	230	230	230	190	190	190					
8150/-0787-0480-...-3.1	3	510	510	510	510	411	411	411	411	411	411	411	411	411	345	345	345	345	345	285	285	285					
8150/-0787-0480-...-3.1	4	680	680	680	680	548	548	548	548	--	--	548	548	548	460	460	460	460	--	380	380	380					
8150/-0787-0480-...-3.1	5	850	850	850	--	--	--	--	--	--	--	--	--	--	--	--	--	--	--	--	--	--					

Note

	Order numbers for enclosures with mounting rails and PE or PA rails
Specify with order	Line-up terminals: number and type
Cable glands	Number, type and installation side in enclosure
Flanges	can be fitted to order; please indicate the side on which they are to be fitted.
Terminals	Phoenix; Weidmüller available on request
Available enclosure depths	230 mm
Terminal boxes fitted with terminals > 35 mm ² up to 300 mm ² on request.	

Table showing the max. number of possible entries of the enclosure using cable glands series 8161

 D = 230 mm A = on request	W x H	without flange				Flange	
	787 x 480	A	B	C	D	A/B	C/D
M16 x 1.5	117	117	190	190	47		
M20 x 1.5	74	74	131	131	31		
M25 x 1.5	46	46	94	94	21		
M32 x 1.5	33	33	63	63	15	a	
M40 x 1.5	36	36	36	36	8		
M50 x 1.5	22	22	22	22	5		
M63 x 1.5	14	14	14	14	5		

Dimensional Drawing (All Dimensions in mm) - Subject to Alterations

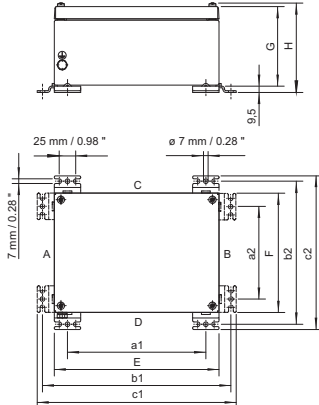
	Dimensions in mm	Depth
		230 mm
a1	747	747
a2	440	440
b1	823	823
b2	516	516
c1	839	839
c2	532	532
E	787	787
F	480	480
G	230	230
H	245	243.5

12648E00

Type
8150/-0787-0480-230-..1.
8150/-0480-0787-230-..2.*

* with hinge or sash lock

Terminal Boxes

Series 8150

Explosion Protection		
Version	8150/1	8150/2
Global (IECEX)		
Gas and dust	IECEX PTB 09.0048 Ex db eb ia/ib mb IIA, IIB, IIC T6 (Ta = -60 ... +40 °C) Ex db eb ia/ib mb IIA, IIB, IIC T5 (Ta = -60 ... +55 °C) Ex db eb ia/ib mb IIA, IIB, IIC T4 (Ta = -60 ... +70 °C) Ex tb IIIC IP66 T130°C (Ta = -60 ... +70 °C) Ex tb IIIC IP66 T95°C (Ta = -60 ... +55 °C) Ex tb IIIC IP66 T80°C (Ta = -60 ... +40 °C)	IECEX PTB 09.0048 Ex ia/ib IIA, IIB, IIC T6 (Ta = -60 ... +75 °C) Ex tb IIIC IP66 T80°C (Ta = -60 ... +75 °C)
Europe (ATEX)		
Gas and dust	PTB 09 ATEX 1108 ⊕ II 2 G Ex db eb ia/ib mb IIA, IIB, IIC T6 (Ta = -60 ... +40 °C) ⊕ II 2 G Ex db eb ia/ib mb IIA, IIB, IIC T5 (Ta = -60 ... +55 °C) ⊕ II 2 G Ex db eb ia/ib mb IIA, IIB, IIC T4 (Ta = -60 ... +70 °C) ⊕ II 2 D Ex tb IIIC IP66 T130°C (Ta = -60 ... +70 °C) ⊕ II 2 D Ex tb IIIC IP66 T95°C (Ta = -60 ... +55 °C) ⊕ II 2 D Ex tb IIIC IP66 T80°C (Ta = -60 ... +40 °C)	PTB 09 ATEX 1108 ⊕ II 2 G Ex ia/ib IIA, IIB, IIC T6 (Ta = -60 ... +75 °C) ⊕ II 2 D Ex tb IIIC IP66 T80°C (Ta = -60 ... +75 °C)
Certificates and approvals		
Certificates	IECEX, ATEX, Brazil (UI do Brasil), India (PESO), Russia (GOST-R), Belarus (GOST-B)	
Types of protection	depending on the actual fitted components used and their type of protection	
Technical data		
Electrical data		
Rated operational voltage	max. 1100 V depending on terminal types and explosion protected components that are used	
Rated operational current	max. 630 A depending on terminal types and explosion protected components used	
Ambient conditions		
Ambient temperature	see explosion protection data depending on terminal types and explosion protected components used	
Mechanical data		
Degree of protection	IP66 acc. to IEC/EN 60529	
Material		
Enclosure	- stainless steel V1.4301 (AISI 304) respectively 1.4404 (AISI 316L) brush finished	
Seal	Silicone, foamed	
Mounting plate	sheet steel, galvanized	
Cover options	- with captive M6 stainless steel combo head screws or - with hinges / cam locks Double-bit key no. 5 for cam lock included in delivery	
Flange		
Standard version	without flange	
Special version	with flange	
Wall thickness		
Enclosure cover	min. 2 mm	
Mounting plate	3 mm	
Cover screws tightening torque	4.5 Nm	
Protective conductor connection	M8 blind rivet nut (1x): at the outside of the enclosure M8 rivet nut (1x): on mounting plate M6 bolt (1x): additionally on enclosures with cover hinges	
Rated cross-section	max. 300 mm ² depending on terminal types and explosion protected components used	
Note		
	please refer to the manufacturer's terminal data, e.g. the tightening torque	

Terminal Boxes

Series 8150

Accessories and Spare Parts

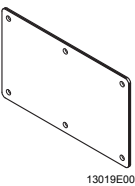
Designation	Illustration	Order number	Depth	Material thickness [mm]	Material				
					Side C/D		Side A/B		
					1.4301	1.4404	1.4301	1.4404	
Flanges		8150/.-0176-0116-....3.1	91	-	-	-	-	-	
		8150/.-0176-0176-....3.1	91	-	a	a	a	a	
		8150/.-0236-0176-....3.1	91	3	202965	202966	a	a	
				5	202967	202968	a	a	
		8150/.-0360-0176-....3.1	91	3	202961	202962	a	a	
				5	202963	202964	a	a	
				150	3	202892	202893	202885	202886
					5	202894	202895	202887	202888
		8150/.-0360-0360-....3.1	91	3	202961	202962	202961	202962	
				5	202963	202964	202963	202964	
			150	3	202892	202893	202892	202893	
				5	202894	202895	202894	202895	
			190	3	a	a	a	a	
				5	a	a	a	a	
		8150/.-0400-0300-....3.1	150	3	202892	202893	a	a	
				5	202894	202895	a	a	
			230	3	202896	202897	a	a	
				5	202898	202899	a	a	
		8150/.-0400-0400-....3.1	150	3	202892	202893	202892	202893	
				5	202894	202895	202894	202895	
			230	3	202896	202897	202896	202897	
				5	202898	202899	202898	202899	
		8150/.-0550-0360-....3.1	230	3	202900	202901	202896	202897	
				5	202902	202903	202898	202899	
		8150/.-0600-0400-....3.1	230	3	202900	202901	202896	202897	
				5	202902	202903	202898	202899	
		8150/.-0727-0360-....3.1	150	3	a	a	202892	202893	
				5	a	a	202894	202895	
		8150/.-0600-0600-....3.1	150	3	202904	202905	202904	202905	
				5	202906	202907	202906	202907	
230	3		202900	202901	202900	202901			
	5		202902	202903	202902	202903			
8150/.-0787-0480-....3.1	230	3	202953	202954	202896	202897			
		5	202955	202956	202898	202899			

a = on request

We reserve the right to make alterations to the technical data, dimensions, weights, designs and products available without notice.
The illustrations cannot be considered binding.