

Control switch/load disconnect switch Series 8008



- > Versions
 - Control switch with 2, 3 or 4 pole
 - Load switch 3 pole + 1 auxiliary contact
- > Rated operational voltage up to 690 V AC
- > Positive opening contacts
- > Contacts suitable for EM-STOP
- > Isolating characteristics according to IEC/EN 60947-3
- > Latching or spring-return versions available



E4

www.stahl.de

18172E00

The control switches series 8008 can be used for EMERGENCY STOP functions according to IEC/EN 60204, DIN VDE 0113. The switching function can be selected, it is available in latching or spring-return version. The load switches meet all requirements for use as motor or main switch.

	ATEX / IECEx						Zone	Class I (NEC 505) (NEC 506)						Division	Class I		Class II		Class III	
	0	1	2	20	21	22		0	1	2	20	21	22		1	2	1	2	1	2
For use	x	x					For use in	x	x					x		x	x	x		

Explosion Protection

Global (IECEx)

Gas and mining	IECEx PTB 06.0010U Ex db eb IIC Gb Ex db eb I Mb
----------------	--

Europe (ATEX)

Gas and mining	PTB 00 ATEX 1111 U ⊕ II 2 G Ex db eb IIC Gb ⊕ I M2 Ex db eb I Mb
----------------	--

Certifications and certificates

Certificates	IECEx, ATEX, USA (UL), Canada (UL)
--------------	------------------------------------

WebCode 8008A

Control switch/load disconnect switch

Series 8008

Selection Table

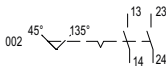
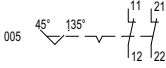
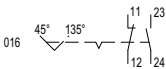
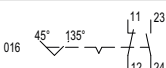
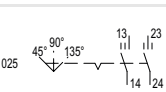
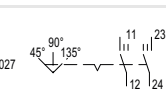
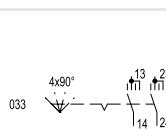
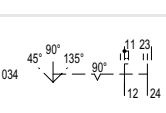
Version	Switching arrangements Assembly Additional information	Order number	Weight kg																												
8008/2 Control switch, 2 pole  01832E00	<table border="1" data-bbox="421 555 504 636"> <tr><td></td><td></td><td>13</td><td>23</td></tr> <tr><td>45°</td><td></td><td></td><td></td></tr> <tr><td>135°</td><td>X</td><td>X</td><td></td></tr> <tr><td></td><td></td><td>14</td><td>24</td></tr> </table> 002  08765E00			13	23	45°				135°	X	X				14	24	8008 / 2 - 002	0.128												
		13	23																												
45°																															
135°	X	X																													
		14	24																												
	<table border="1" data-bbox="421 775 504 855"> <tr><td></td><td></td><td>11</td><td>21</td></tr> <tr><td>45°</td><td>X</td><td>X</td><td></td></tr> <tr><td>135°</td><td></td><td></td><td></td></tr> <tr><td></td><td></td><td>12</td><td>22</td></tr> </table> 005  07134E00			11	21	45°	X	X		135°						12	22	8008 / 2 - 005	0.128												
		11	21																												
45°	X	X																													
135°																															
		12	22																												
	<table border="1" data-bbox="421 931 504 1012"> <tr><td></td><td></td><td>11</td><td>23</td></tr> <tr><td>45°</td><td>X</td><td></td><td></td></tr> <tr><td>135°</td><td></td><td>X</td><td></td></tr> <tr><td></td><td></td><td>12</td><td>24</td></tr> </table> 016  08857E00			11	23	45°	X			135°		X				12	24	8008 / 2 - 016	0.128												
		11	23																												
45°	X																														
135°		X																													
		12	24																												
	<table border="1" data-bbox="421 1088 504 1169"> <tr><td></td><td></td><td>11</td><td>23</td></tr> <tr><td>45°</td><td>X</td><td></td><td></td></tr> <tr><td>135°</td><td></td><td>X</td><td></td></tr> <tr><td></td><td></td><td>12</td><td>24</td></tr> </table> 016 Gold contacts  08857E00			11	23	45°	X			135°		X				12	24	8008 / 2 - 016 - AU	0.128												
		11	23																												
45°	X																														
135°		X																													
		12	24																												
	<table border="1" data-bbox="421 1245 504 1357"> <tr><td></td><td></td><td>13</td><td>23</td></tr> <tr><td>45°</td><td></td><td></td><td></td></tr> <tr><td>90°</td><td>X</td><td></td><td></td></tr> <tr><td>135°</td><td></td><td>X</td><td></td></tr> <tr><td></td><td></td><td>14</td><td>24</td></tr> </table> 025  08754E00			13	23	45°				90°	X			135°		X				14	24	8008 / 2 - 025	0.128								
		13	23																												
45°																															
90°	X																														
135°		X																													
		14	24																												
	<table border="1" data-bbox="421 1424 504 1536"> <tr><td></td><td></td><td>11</td><td>23</td></tr> <tr><td>45°</td><td>X</td><td></td><td></td></tr> <tr><td>90°</td><td></td><td></td><td></td></tr> <tr><td>135°</td><td></td><td>X</td><td></td></tr> <tr><td></td><td></td><td>12</td><td>24</td></tr> </table> 027  08758E00			11	23	45°	X			90°				135°		X				12	24	8008 / 2 - 027	0.128								
		11	23																												
45°	X																														
90°																															
135°		X																													
		12	24																												
	<table border="1" data-bbox="421 1603 504 1783"> <tr><td></td><td></td><td>13</td><td>23</td></tr> <tr><td>0°/360°</td><td></td><td></td><td></td></tr> <tr><td>90°</td><td>X</td><td>X</td><td></td></tr> <tr><td>180°</td><td></td><td></td><td></td></tr> <tr><td>270°</td><td>X</td><td>X</td><td></td></tr> <tr><td>360°/0°</td><td></td><td></td><td></td></tr> <tr><td></td><td></td><td>14</td><td>24</td></tr> </table> 033  08756E00			13	23	0°/360°				90°	X	X		180°				270°	X	X		360°/0°						14	24	8008 / 2 - 033	0.128
		13	23																												
0°/360°																															
90°	X	X																													
180°																															
270°	X	X																													
360°/0°																															
		14	24																												
	<table border="1" data-bbox="421 1850 504 1984"> <tr><td></td><td></td><td>11</td><td>23</td></tr> <tr><td>45°</td><td></td><td></td><td></td></tr> <tr><td>90°</td><td>X</td><td></td><td></td></tr> <tr><td>135°</td><td>X</td><td>X</td><td></td></tr> <tr><td></td><td></td><td>12</td><td>24</td></tr> </table> 034  08766E00			11	23	45°				90°	X			135°	X	X				12	24	8008 / 2 - 034	0.128								
		11	23																												
45°																															
90°	X																														
135°	X	X																													
		12	24																												

Control switch/load disconnect switch

Series 8008



Selection Table

Version	Switching arrangements Assembly Additional information	Order number	Weight kg																					
	<table border="1"> <tr><td>0°/360°</td><td>X</td><td></td></tr> <tr><td>60°</td><td></td><td>X</td></tr> <tr><td>120°</td><td>X</td><td></td></tr> <tr><td>180°</td><td></td><td>X</td></tr> <tr><td>240°</td><td>X</td><td></td></tr> <tr><td>300°</td><td></td><td>X</td></tr> <tr><td>360°/0°</td><td>X</td><td></td></tr> </table> <p>11 23 12 24</p> <p>035</p> <p>08760E00</p>	0°/360°	X		60°		X	120°	X		180°		X	240°	X		300°		X	360°/0°	X		8008 / 2-035	0.128
0°/360°	X																							
60°		X																						
120°	X																							
180°		X																						
240°	X																							
300°		X																						
360°/0°	X																							
	<table border="1"> <tr><td>45°</td><td></td><td></td></tr> <tr><td>90°</td><td></td><td>X</td></tr> <tr><td>135°</td><td>X</td><td>X</td></tr> </table> <p>13 23 14 24</p> <p>038</p> <p>08767E00</p>	45°			90°		X	135°	X	X	8008 / 2-038	0.128												
45°																								
90°		X																						
135°	X	X																						
	<table border="1"> <tr><td>45°</td><td></td><td></td></tr> <tr><td>90°</td><td></td><td>X</td></tr> <tr><td>135°</td><td>X</td><td>X</td></tr> </table> <p>13 23 14 24</p> <p>038</p> <p>08767E00</p>	45°			90°		X	135°	X	X	8008 / 2-038-AU	0.128												
45°																								
90°		X																						
135°	X	X																						
	<table border="1"> <tr><td>45°</td><td>X</td><td></td></tr> <tr><td>90°</td><td></td><td></td></tr> <tr><td>135°</td><td></td><td>X</td></tr> </table> <p>13 23 14 24</p> <p>040</p> <p>08859E00</p>	45°	X		90°			135°		X	8008 / 2-040	0.128												
45°	X																							
90°																								
135°		X																						
	<table border="1"> <tr><td>90°</td><td></td><td></td></tr> <tr><td>135°</td><td>X</td><td>X</td></tr> </table> <p>13 23 14 24</p> <p>045</p> <p>10734E00</p>	90°			135°	X	X	8008 / 2-045	0.128															
90°																								
135°	X	X																						
	<table border="1"> <tr><td>45°</td><td>X</td><td></td></tr> <tr><td>90°</td><td></td><td></td></tr> <tr><td>135°</td><td></td><td>X</td></tr> </table> <p>11 23 12 24</p> <p>047</p> <p>09026E00</p>	45°	X		90°			135°		X	8008 / 2-047	0.128												
45°	X																							
90°																								
135°		X																						
	<table border="1"> <tr><td>45°</td><td>X</td><td>X</td></tr> <tr><td>90°</td><td></td><td>X</td></tr> <tr><td>135°</td><td></td><td></td></tr> </table> <p>13 21 14 22</p> <p>047</p> <p>09027E00</p>	45°	X	X	90°		X	135°			8008 / 2-048	0.128												
45°	X	X																						
90°		X																						
135°																								
	<table border="1"> <tr><td>45°</td><td>X</td><td></td></tr> <tr><td>90°</td><td></td><td></td></tr> <tr><td>135°</td><td></td><td>X</td></tr> </table> <p>13 23 14 24</p> <p>051</p> <p>08770E00</p>	45°	X		90°			135°		X	8008 / 2-051	0.128												
45°	X																							
90°																								
135°		X																						
	<p>035</p> <p>08760E00</p>																							

E4

Control switch/load disconnect switch

Series 8008

Selection Table

Version	Switching arrangements Assembly Additional information	Order number	Weight kg																											
	<table border="1"> <tr><td></td><td>11</td><td>23</td></tr> <tr><td>90°</td><td>X</td><td></td></tr> <tr><td>135°</td><td>X</td><td>X</td></tr> <tr><td></td><td>12</td><td>24</td></tr> </table> 053 06083E00		11	23	90°	X		135°	X	X		12	24	8008 / 2 - 053	0.128															
	11	23																												
90°	X																													
135°	X	X																												
	12	24																												
	<table border="1"> <tr><td></td><td>11</td><td>23</td></tr> <tr><td>0°/360°</td><td>X</td><td></td></tr> <tr><td>60°</td><td></td><td>X</td></tr> <tr><td>120°</td><td>X</td><td></td></tr> <tr><td>180°</td><td></td><td>X</td></tr> <tr><td>240°</td><td>X</td><td></td></tr> <tr><td>300°</td><td></td><td>X</td></tr> <tr><td>360°/0°</td><td>X</td><td></td></tr> <tr><td></td><td>12</td><td>24</td></tr> </table> 1261 07826E00		11	23	0°/360°	X		60°		X	120°	X		180°		X	240°	X		300°		X	360°/0°	X			12	24	8008 / 2 - 1261	0.128
	11	23																												
0°/360°	X																													
60°		X																												
120°	X																													
180°		X																												
240°	X																													
300°		X																												
360°/0°	X																													
	12	24																												
	<table border="1"> <tr><td></td><td>13</td><td>23</td></tr> <tr><td>0°/360°</td><td></td><td></td></tr> <tr><td>90°</td><td>X</td><td>X</td></tr> <tr><td>180°</td><td></td><td></td></tr> <tr><td>270°</td><td>X</td><td>X</td></tr> <tr><td>360°/0°</td><td></td><td></td></tr> <tr><td></td><td>14</td><td>24</td></tr> </table> 1260 07828E00		13	23	0°/360°			90°	X	X	180°			270°	X	X	360°/0°				14	24	8008 / 2 - 1260	0.128						
	13	23																												
0°/360°																														
90°	X	X																												
180°																														
270°	X	X																												
360°/0°																														
	14	24																												
8008/2 Control switch, 4 pole 01833E00	<table border="1"> <tr><td></td><td>13</td><td>23</td><td>33</td><td>43</td></tr> <tr><td>45°</td><td></td><td></td><td></td><td></td></tr> <tr><td>135°</td><td>X</td><td>X</td><td>X</td><td>X</td></tr> <tr><td></td><td>14</td><td>24</td><td>34</td><td>44</td></tr> </table> 102 08860E00		13	23	33	43	45°					135°	X	X	X	X		14	24	34	44	8008 / 2 - 102	0.186							
		13	23	33	43																									
	45°																													
	135°	X	X	X	X																									
	14	24	34	44																										
<table border="1"> <tr><td></td><td>13</td><td>23</td><td>31</td><td>41</td></tr> <tr><td>45°</td><td></td><td></td><td>X</td><td>X</td></tr> <tr><td>135°</td><td>X</td><td>X</td><td></td><td></td></tr> <tr><td></td><td>14</td><td>24</td><td>32</td><td>42</td></tr> </table> 106 08861E00		13	23	31	41	45°			X	X	135°	X	X				14	24	32	42	8008 / 2 - 106	0.186								
	13	23	31	41																										
45°			X	X																										
135°	X	X																												
	14	24	32	42																										
<table border="1"> <tr><td></td><td>13</td><td>23</td><td>31</td><td>41</td></tr> <tr><td>45°</td><td>X</td><td>X</td><td>X</td><td>X</td></tr> <tr><td>135°</td><td>X</td><td>X</td><td>X</td><td>X</td></tr> <tr><td></td><td>14</td><td>24</td><td>32</td><td>42</td></tr> </table> 107 10745E00		13	23	31	41	45°	X	X	X	X	135°	X	X	X	X		14	24	32	42	8008 / 2 - 107	0.186								
	13	23	31	41																										
45°	X	X	X	X																										
135°	X	X	X	X																										
	14	24	32	42																										
<table border="1"> <tr><td></td><td>13</td><td>23</td><td>33</td><td>43</td></tr> <tr><td>45°</td><td></td><td></td><td></td><td></td></tr> <tr><td>135°</td><td>X</td><td>X</td><td>X</td><td>X</td></tr> <tr><td></td><td>14</td><td>24</td><td>34</td><td>44</td></tr> </table> 108 10746E00		13	23	33	43	45°					135°	X	X	X	X		14	24	34	44	8008 / 2 - 108	0.186								
	13	23	33	43																										
45°																														
135°	X	X	X	X																										
	14	24	34	44																										

Control switch/load disconnect switch

Series 8008



Selection Table

Version	Switching arrangements Assembly Additional information	Order number	Weight kg																																				
110	<table border="1"> <tr><td></td><td></td><td>11</td><td>23</td><td>33</td><td>43</td></tr> <tr><td>0°</td><td>X</td><td></td><td></td><td></td><td></td></tr> <tr><td>45°</td><td></td><td>X</td><td></td><td></td><td></td></tr> <tr><td>90°</td><td></td><td></td><td>X</td><td></td><td></td></tr> <tr><td>135°</td><td></td><td></td><td></td><td>X</td><td></td></tr> <tr><td></td><td></td><td>12</td><td>24</td><td>34</td><td>44</td></tr> </table> <p>08862E00</p>			11	23	33	43	0°	X					45°		X				90°			X			135°				X				12	24	34	44	8008/2-110	0.186
		11	23	33	43																																		
0°	X																																						
45°		X																																					
90°			X																																				
135°				X																																			
		12	24	34	44																																		
113	<table border="1"> <tr><td></td><td></td><td>13</td><td>21</td><td>33</td><td>43</td></tr> <tr><td>45°</td><td></td><td>X</td><td></td><td></td><td></td></tr> <tr><td>90°</td><td>X</td><td></td><td></td><td></td><td></td></tr> <tr><td>135°</td><td></td><td></td><td>X</td><td>X</td><td></td></tr> <tr><td></td><td></td><td>14</td><td>22</td><td>34</td><td>44</td></tr> </table> <p>10747E00</p>			13	21	33	43	45°		X				90°	X					135°			X	X				14	22	34	44	8008/2-113	0.186						
		13	21	33	43																																		
45°		X																																					
90°	X																																						
135°			X	X																																			
		14	22	34	44																																		
119	<table border="1"> <tr><td></td><td></td><td>11</td><td>23</td><td>31</td><td>43</td></tr> <tr><td>45°</td><td>X</td><td></td><td>X</td><td></td><td></td></tr> <tr><td>90°</td><td></td><td></td><td></td><td>X</td><td></td></tr> <tr><td>135°</td><td></td><td>X</td><td></td><td>X</td><td></td></tr> <tr><td></td><td></td><td>12</td><td>24</td><td>32</td><td>44</td></tr> </table> <p>08768E00</p>			11	23	31	43	45°	X		X			90°				X		135°		X		X				12	24	32	44	8008/2-119	0.186						
		11	23	31	43																																		
45°	X		X																																				
90°				X																																			
135°		X		X																																			
		12	24	32	44																																		
124	<table border="1"> <tr><td></td><td></td><td>13</td><td>21</td><td>31</td><td>43</td></tr> <tr><td>0°</td><td></td><td>X</td><td></td><td>X</td><td></td></tr> <tr><td>45°</td><td></td><td></td><td>X</td><td></td><td></td></tr> <tr><td>90°</td><td></td><td>X</td><td>X</td><td></td><td></td></tr> <tr><td>135°</td><td>X</td><td>X</td><td>X</td><td></td><td></td></tr> <tr><td></td><td></td><td>14</td><td>22</td><td>32</td><td>44</td></tr> </table> <p>08627E00</p>			13	21	31	43	0°		X		X		45°			X			90°		X	X			135°	X	X	X					14	22	32	44	8008/2-124	0.186
		13	21	31	43																																		
0°		X		X																																			
45°			X																																				
90°		X	X																																				
135°	X	X	X																																				
		14	22	32	44																																		
127	<table border="1"> <tr><td></td><td></td><td>13</td><td>23</td><td>33</td><td>43</td></tr> <tr><td>45°</td><td>X</td><td></td><td>X</td><td></td><td></td></tr> <tr><td>90°</td><td></td><td></td><td></td><td>X</td><td></td></tr> <tr><td>135°</td><td></td><td>X</td><td></td><td>X</td><td></td></tr> <tr><td></td><td></td><td>14</td><td>24</td><td>34</td><td>44</td></tr> </table> <p>07368E00</p>			13	23	33	43	45°	X		X			90°				X		135°		X		X				14	24	34	44	8008/2-127	0.186						
		13	23	33	43																																		
45°	X		X																																				
90°				X																																			
135°		X		X																																			
		14	24	34	44																																		
130	<table border="1"> <tr><td></td><td></td><td>11</td><td>23</td><td>33</td><td>41</td></tr> <tr><td>0°</td><td>X</td><td>X</td><td>X</td><td>X</td><td></td></tr> <tr><td>45°</td><td>X</td><td></td><td></td><td>X</td><td></td></tr> <tr><td>90°</td><td></td><td></td><td></td><td></td><td>X</td></tr> <tr><td>135°</td><td></td><td></td><td>X</td><td></td><td></td></tr> <tr><td></td><td></td><td>12</td><td>24</td><td>34</td><td>42</td></tr> </table> <p>10839E00</p>			11	23	33	41	0°	X	X	X	X		45°	X			X		90°					X	135°			X					12	24	34	42	8008/2-130	0.186
		11	23	33	41																																		
0°	X	X	X	X																																			
45°	X			X																																			
90°					X																																		
135°			X																																				
		12	24	34	42																																		
139	<table border="1"> <tr><td></td><td></td><td>11</td><td>23</td><td>33</td><td>43</td></tr> <tr><td>45°</td><td>X</td><td></td><td></td><td></td><td></td></tr> <tr><td>90°</td><td></td><td>X</td><td></td><td>X</td><td></td></tr> <tr><td>135°</td><td></td><td></td><td>X</td><td>X</td><td></td></tr> <tr><td></td><td></td><td>12</td><td>24</td><td>34</td><td>44</td></tr> </table> <p>07369E00</p>			11	23	33	43	45°	X					90°		X		X		135°			X	X				12	24	34	44	8008/2-139	0.186						
		11	23	33	43																																		
45°	X																																						
90°		X		X																																			
135°			X	X																																			
		12	24	34	44																																		
145	<table border="1"> <tr><td></td><td></td><td>13</td><td>21</td><td>33</td><td></td></tr> <tr><td>45°</td><td>X</td><td></td><td></td><td></td><td></td></tr> <tr><td>90°</td><td></td><td>X</td><td></td><td></td><td></td></tr> <tr><td>135°</td><td></td><td></td><td>X</td><td></td><td></td></tr> <tr><td></td><td></td><td>14</td><td>22</td><td>34</td><td></td></tr> </table> <p>10789E00</p>			13	21	33		45°	X					90°		X				135°			X					14	22	34		8008/2-145	0.186						
		13	21	33																																			
45°	X																																						
90°		X																																					
135°			X																																				
		14	22	34																																			

E4

Control switch/load disconnect switch

Series 8008

Selection Table

Version	Switching arrangements Assembly Additional information	Order number	Weight kg																																			
148	<table border="1"> <tr><td></td><td>13</td><td>23</td><td>31</td><td>41</td></tr> <tr><td>0°</td><td></td><td></td><td>X</td><td>X</td></tr> <tr><td>45°</td><td></td><td></td><td></td><td></td></tr> <tr><td>90°</td><td></td><td>X</td><td></td><td></td></tr> <tr><td>135°</td><td>X</td><td>X</td><td></td><td></td></tr> <tr><td></td><td>14</td><td>24</td><td>32</td><td>42</td></tr> </table> <p>10926E00</p>		13	23	31	41	0°			X	X	45°					90°		X			135°	X	X				14	24	32	42	8008/2-148	0.186					
	13	23	31	41																																		
0°			X	X																																		
45°																																						
90°		X																																				
135°	X	X																																				
	14	24	32	42																																		
162	<table border="1"> <tr><td></td><td>13</td><td>21</td><td>33</td><td>41</td></tr> <tr><td>45°</td><td>X</td><td>X</td><td></td><td></td></tr> <tr><td>90°</td><td></td><td>X</td><td></td><td>X</td></tr> <tr><td>135°</td><td></td><td></td><td>X</td><td>X</td></tr> <tr><td></td><td>14</td><td>22</td><td>34</td><td>42</td></tr> </table> <p>07370E00</p>		13	21	33	41	45°	X	X			90°		X		X	135°			X	X		14	22	34	42	8008/2-162	0.186										
	13	21	33	41																																		
45°	X	X																																				
90°		X		X																																		
135°			X	X																																		
	14	22	34	42																																		
163	<table border="1"> <tr><td></td><td>6</td><td>4</td><td>2*</td></tr> <tr><td>45°</td><td></td><td></td><td>X</td></tr> <tr><td>90°</td><td>X</td><td></td><td></td></tr> <tr><td>135°</td><td>X</td><td>X</td><td></td></tr> <tr><td></td><td>5</td><td>3</td><td>1*</td></tr> </table> <p>02449E00</p> <p>Attention! The contact 2-1 is a normally open contact with positive closing</p>		6	4	2*	45°			X	90°	X			135°	X	X			5	3	1*	8008/2-163	0.186															
	6	4	2*																																			
45°			X																																			
90°	X																																					
135°	X	X																																				
	5	3	1*																																			
170	<table border="1"> <tr><td></td><td>11</td><td>21</td><td>33</td><td>43</td></tr> <tr><td>45°</td><td>X</td><td>X</td><td></td><td></td></tr> <tr><td>90°</td><td></td><td>X</td><td></td><td>X</td></tr> <tr><td>135°</td><td></td><td></td><td>X</td><td>X</td></tr> <tr><td></td><td>12</td><td>22</td><td>34</td><td>44</td></tr> </table> <p>10840E00</p>		11	21	33	43	45°	X	X			90°		X		X	135°			X	X		12	22	34	44	8008/2-170	0.186										
	11	21	33	43																																		
45°	X	X																																				
90°		X		X																																		
135°			X	X																																		
	12	22	34	44																																		
196	<table border="1"> <tr><td></td><td>13</td><td>23</td><td>33</td><td>PE</td></tr> <tr><td>0°/360°</td><td></td><td></td><td></td><td></td></tr> <tr><td>90°</td><td>X</td><td>X</td><td>X</td><td></td></tr> <tr><td>180°</td><td></td><td></td><td></td><td></td></tr> <tr><td>270°</td><td>X</td><td>X</td><td>X</td><td></td></tr> <tr><td>360°/0°</td><td></td><td></td><td></td><td></td></tr> <tr><td></td><td>14</td><td>24</td><td>34</td><td>N</td></tr> </table> <p>02450E00</p>		13	23	33	PE	0°/360°					90°	X	X	X		180°					270°	X	X	X		360°/0°						14	24	34	N	8008/2-196	0.186
	13	23	33	PE																																		
0°/360°																																						
90°	X	X	X																																			
180°																																						
270°	X	X	X																																			
360°/0°																																						
	14	24	34	N																																		
197	<table border="1"> <tr><td></td><td>6</td><td>4</td><td>2</td></tr> <tr><td>45°</td><td></td><td></td><td>X</td></tr> <tr><td>90°</td><td>X</td><td></td><td></td></tr> <tr><td>135°</td><td>X</td><td>X</td><td></td></tr> <tr><td></td><td>5</td><td>3</td><td>1</td></tr> </table> <p>02451E00</p> <p>Attention! The contact 2-1 is a normally open contact with positive closing</p>		6	4	2	45°			X	90°	X			135°	X	X			5	3	1	8008/2-197	0.186															
	6	4	2																																			
45°			X																																			
90°	X																																					
135°	X	X																																				
	5	3	1																																			
1114	<table border="1"> <tr><td></td><td>13</td><td>23</td><td>31</td><td>43</td></tr> <tr><td>0°</td><td>X</td><td></td><td></td><td></td></tr> <tr><td>45°</td><td></td><td>X</td><td></td><td></td></tr> <tr><td>90°</td><td></td><td></td><td>X</td><td></td></tr> <tr><td>135°</td><td></td><td></td><td></td><td>X</td></tr> <tr><td></td><td>14</td><td>24</td><td>32</td><td>44</td></tr> </table> <p>10927E00</p>		13	23	31	43	0°	X				45°		X			90°			X		135°				X		14	24	32	44	8008/2-1114	0.186					
	13	23	31	43																																		
0°	X																																					
45°		X																																				
90°			X																																			
135°				X																																		
	14	24	32	44																																		
1136	<table border="1"> <tr><td></td><td>13</td><td>21</td><td>33</td><td>43</td></tr> <tr><td>0°</td><td>X</td><td></td><td></td><td></td></tr> <tr><td>45°</td><td></td><td>X</td><td></td><td></td></tr> <tr><td>90°</td><td></td><td></td><td>X</td><td></td></tr> <tr><td>135°</td><td></td><td></td><td></td><td>X</td></tr> <tr><td></td><td>14</td><td>22</td><td>34</td><td>44</td></tr> </table> <p>10833E00</p>		13	21	33	43	0°	X				45°		X			90°			X		135°				X		14	22	34	44	8008/2-1136	0.186					
	13	21	33	43																																		
0°	X																																					
45°		X																																				
90°			X																																			
135°				X																																		
	14	22	34	44																																		

Control switch/load disconnect switch

Series 8008



Selection Table

Version	Switching arrangements Assembly Additional information	Order number	Weight kg																														
	<table border="1"> <tr><td></td><td>1</td><td>3</td><td>5</td></tr> <tr><td>0°</td><td></td><td></td><td></td></tr> <tr><td>90°</td><td>X</td><td>X</td><td>X</td></tr> <tr><td></td><td>2</td><td>4</td><td>6</td></tr> </table> <p>1140</p> <p>05697E00</p>		1	3	5	0°				90°	X	X	X		2	4	6	8008 / 2-1140	0.186														
	1	3	5																														
0°																																	
90°	X	X	X																														
	2	4	6																														
	<table border="1"> <tr><td></td><td>11</td><td>23</td><td>33</td><td>43</td></tr> <tr><td>0°</td><td>X</td><td></td><td></td><td></td></tr> <tr><td>45°</td><td></td><td>X</td><td></td><td></td></tr> <tr><td>90°</td><td></td><td></td><td>X</td><td></td></tr> <tr><td>135°</td><td></td><td></td><td></td><td>X</td></tr> <tr><td></td><td>12</td><td>24</td><td>34</td><td>44</td></tr> </table> <p>1168</p> <p>10835E00</p>		11	23	33	43	0°	X				45°		X			90°			X		135°				X		12	24	34	44	8008 / 2-1168	0.186
	11	23	33	43																													
0°	X																																
45°		X																															
90°			X																														
135°				X																													
	12	24	34	44																													
	<table border="1"> <tr><td></td><td>11</td><td>23</td><td>31</td><td>43</td></tr> <tr><td>45°</td><td>X</td><td>X</td><td></td><td></td></tr> <tr><td>90°</td><td>X</td><td></td><td>X</td><td></td></tr> <tr><td>135°</td><td></td><td></td><td></td><td>X</td></tr> <tr><td></td><td>12</td><td>24</td><td>32</td><td>44</td></tr> </table> <p>1178</p> <p>10929E00</p>		11	23	31	43	45°	X	X			90°	X		X		135°				X		12	24	32	44	8008 / 2-1178	0.186					
	11	23	31	43																													
45°	X	X																															
90°	X		X																														
135°				X																													
	12	24	32	44																													
	<table border="1"> <tr><td></td><td>13</td><td>21</td><td>33</td><td>43</td></tr> <tr><td>0°</td><td>X</td><td></td><td>X</td><td></td></tr> <tr><td>45°</td><td></td><td></td><td>X</td><td></td></tr> <tr><td>90°</td><td></td><td>X</td><td></td><td></td></tr> <tr><td>135°</td><td></td><td></td><td></td><td>X</td></tr> <tr><td></td><td>14</td><td>22</td><td>34</td><td>44</td></tr> </table> <p>1207</p> <p>10928E00</p>		13	21	33	43	0°	X		X		45°			X		90°		X			135°				X		14	22	34	44	8008 / 2-1207	0.186
	13	21	33	43																													
0°	X		X																														
45°			X																														
90°		X																															
135°				X																													
	14	22	34	44																													

E4

Control switch/load disconnect switch

Series 8008

Selection Table

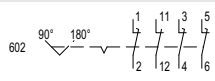
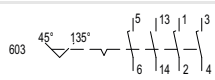
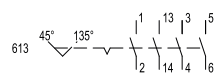
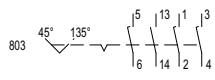
Version	Switching arrangements Assembly Additional information	Order number	Weight kg																				
8008/2 Load switch 3 pole + auxiliary contact  01833E00	<table border="1"> <tr><td></td><td>1</td><td>11</td><td>3</td><td>5</td></tr> <tr><td>90°</td><td>X</td><td>X</td><td>X</td><td>X</td></tr> <tr><td>180°</td><td></td><td></td><td></td><td></td></tr> <tr><td></td><td>2</td><td>12</td><td>4</td><td>6</td></tr> </table> 602  10836E00		1	11	3	5	90°	X	X	X	X	180°						2	12	4	6	8008/2-602	0.225
		1	11	3	5																		
	90°	X	X	X	X																		
	180°																						
	2	12	4	6																			
<table border="1"> <tr><td></td><td>5</td><td>13</td><td>1</td><td>3</td></tr> <tr><td>45°</td><td>X</td><td>X</td><td>X</td><td>X</td></tr> <tr><td>135°</td><td></td><td></td><td></td><td></td></tr> <tr><td></td><td>6</td><td>14</td><td>2</td><td>4</td></tr> </table> 603  10837E00		5	13	1	3	45°	X	X	X	X	135°						6	14	2	4	8008/2-603	0.225	
	5	13	1	3																			
45°	X	X	X	X																			
135°																							
	6	14	2	4																			
<table border="1"> <tr><td></td><td>1</td><td>13</td><td>3</td><td>5</td></tr> <tr><td>45°</td><td></td><td></td><td></td><td></td></tr> <tr><td>135°</td><td>X</td><td>X</td><td>X</td><td>X</td></tr> <tr><td></td><td>2</td><td>14</td><td>4</td><td>6</td></tr> </table> 613  10838E00		1	13	3	5	45°					135°	X	X	X	X		2	14	4	6	8008/2-613	0.225	
	1	13	3	5																			
45°																							
135°	X	X	X	X																			
	2	14	4	6																			
<table border="1"> <tr><td></td><td>5</td><td>13</td><td>1</td><td>3</td></tr> <tr><td>45°</td><td>X</td><td>X</td><td>X</td><td>X</td></tr> <tr><td>135°</td><td></td><td></td><td></td><td></td></tr> <tr><td></td><td>6</td><td>14</td><td>2</td><td>4</td></tr> </table> 6803 safety switch  11005E00		5	13	1	3	45°	X	X	X	X	135°						6	14	2	4	8008/2-6803-C1211	0.225	
	5	13	1	3																			
45°	X	X	X	X																			
135°																							
	6	14	2	4																			

Note

The standard contact arrangements are examples, other 3 or 4 pole versions are available

Technical Data

Electrical data

Rated insulation voltage	max. 690 V AC
Rated frequency	50 / 60 Hz
Rated operational voltage	max. 690 V AC / 230 V DC
Rated impulse withstand voltage	max. 6 kV (load disconnect switch), 4 kV (control switch)
Rated operational current	max. 16 A
Contacts	max. 4-pole; NC with positive opening for EM-STOP

Control switch/load disconnect switch

Series 8008



Technical Data

Switching capacity	acc. to IEC/EN 60947-1; IEC/EN 60947-3; IEC/EN 60947-5-1: Control switch 8008/2-0, 8008/2-1			
	AC-1	AC-11	AC-15	DC-13 (L/R=300 ms)
	690 V, 16 A	660 V, 2.5 A 500 V, 4 A 380 V, 6 A 220 V, 6 A	415 V, 16 A	230 V, 0.4 A
	DC-11 (L/R=100 ms)	DC-11 (L/R=50 ms)	DC-11 (L/R=1 ms)	
	220 V, 0.4 A	220 V, 0.6 A	220 V, 1.0 A	
	110 V, 1.0 A	110 V, 1.6 A	110 V, 4.0 A	
	60 V, 4.0 A	60 V, 6.0 A	60 V, 16.0 A	
	Load disconnect switch 8008/2-6			
	AC-3	DC-1	DC-3	DC-5
	690 V, 16 A	60 V, 10 A ¹⁾ 60 V, 10 A ²⁾ 110 V, 10 A ²⁾ 60 V, 10 A ³⁾ 110 V, 10 A ³⁾ 220 V, 10 A ³⁾	60 V, 4 A ¹⁾ 60 V, 10 A ²⁾ 110 V, 6 A ²⁾ 60 V, 10 A ³⁾ 110 V, 10 A ³⁾ 220 V, 4 A ³⁾	60 V, 2.5 A ¹⁾ 60 V, 6 A ²⁾ 110 V, 4 A ²⁾ 60 V, 10 A ³⁾ 110 V, 6 A ³⁾ 220 V, 2 A ³⁾
				¹⁾ 1 conducting path ²⁾ 2 conducting paths in series ³⁾ 3 conducting paths in serie
Short-circuit protection	Back-up fuse max. 32 A gG Note: The overload protection of the consumers must be performed independently of the back-up fuse.			
Rated short-time withstand current I _{cw}	0.3 kA (1s)			
Service life	mechanical: 500,000 operating cycles			
Ambient conditions				
Operating temperature	-60 ... +80 °C			
Contact opening	Control switch	Load disconnect switch		
	8008/2-0 8008/2-1	8008/2-6		
	min. 2 x 2 mm	min. 2 x 3 mm		
Mechanical data				
Material	Epoxy resin			
Enclosure	Silver-nickel, 8008/2-....-AU (gold-plated)			
Contacts	3			
Degree of pollution	3			

E4

Control switch/load disconnect switch

Series 8008

Dimensional Drawings (all dimensions in mm) - Subject to alterations

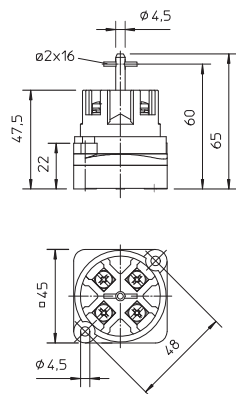

8008/2-0..

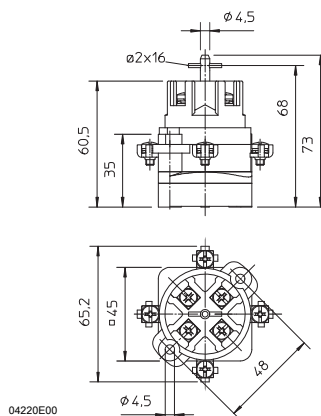

8008/2-1..

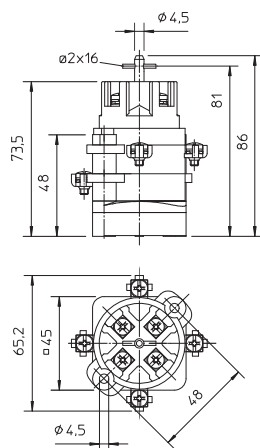

8008/2-6..







Accessories and Spare Parts

Designation	Picture	Description	Note	Art. no.	Weight	
Small rotary actuator with knob		Ø39, can be locked with one lock, 90° position	with standard seal for up to -20 °C	227359	0.040	
		Ø39, can be locked with one lock, 90° position	with silicone seal for up to -60 °C	227360	0.040	
		Ø39, can be locked with one lock, 45° position	with standard seal for up to -20 °C	227391	0.040	
		Ø39, can be locked with one lock, 45° position	with silicone seal for up to -60 °C	227392	0.040	
	Specify labels: see below					

Control switch/load disconnect switch Series 8008



Accessories and Spare Parts

Designation	Picture	Description	Note	Art. no.	Weight
					kg
Additional symbol disc for small actuators		Label holder, size 1, without insert disc, 1-row label	--	223566	
		Label holder, size 2, without insert disc, 1- or 2-row label	--	223567	
		Label holder, size 3, without insert disc, 1-, 2- or 3-row label	--	223568	
	Other designation plates available on request				
Large rotary actuator		Black handle, black protective collar, Ø65, handle in 90° position, uninstalled	with standard seal for up to -20 °C	227223	0.040
		Black handle, black protective collar, Ø65, handle in 90° position, uninstalled	with silicone seal for up to -60 °C	227224	0.040
		Black handle, black protective collar, Ø65, handle in 45° position, uninstalled	with standard seal for up to -20 °C	227225	0.040
		Black handle, black protective collar, Ø65, handle in 45° position, uninstalled	with silicone seal for up to -60 °C	227226	0.040
Specify labels: see below					
Symbol discs for large actuators		Ø58; 0/OFF I/ON	--	227004	0.002
		Ø58; 0 operation I	--	227005	0.002
		Ø58; 0 I II	--	227006	0.002
Other designation plates available on request					
Rotary actuator for safety switch		Black handle, black protective collar, Ø65, handle in 90° position, uninstalled	with silicone seal for up to -60 °C	253174	
		Red handle, yellow protective collar, Ø65, handle in 90° position, pre-installed with 0/OFF I/ON label	with silicone seal for up to -60 °C	253175	

E4

Control switch/load disconnect switch

Series 8008

Accessories and Spare Parts

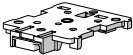
Designation	Picture	Description	Note	Art. no.	Weight
Adaptor		for installation of control switch 8008 on mounting rail TS35	--	130954	0.022 kg

We reserve the right to make alterations to the technical data, dimensions, weights, designs and products available without notice. The illustrations cannot be considered binding.