



Load and Motor Switch / Control Switch Series 8006/4

www.stahl.de



14227E00

- > Isolator features
- > Switching capacity
- > Rated working voltage up to 690 V AC
- > Different switching arrangements available



E9

Load and motor switches Series 8006 meets all requirements for use as motor switches or main switches. Since these switches are components (U-certificate), they must be installed in enclosures with type of protection „Ex e“ increased safety.

Zone	ATEX / IECEx					
	0	1	2	20	21	22
For use in		X	X			

WebCode 8006B

Load and Motor Switch / Control Switch

Series 8006/4

Selection Table

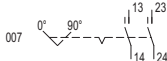
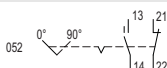
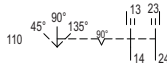
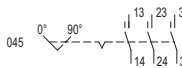
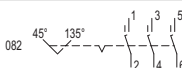
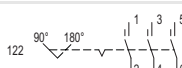
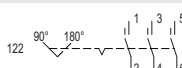
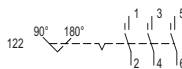
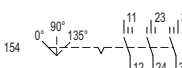
Version	Description	Order number														
 <p>14792E00 Load and motor switch 25 A Series 8006/4</p>	<p>2-pole</p> <table border="1" style="display: inline-table; margin-right: 20px;"> <tr><td>13</td><td>23</td></tr> <tr><td>0°</td><td></td></tr> <tr><td>90°</td><td>X X</td></tr> <tr><td>14</td><td>24</td></tr> </table>  <p>007</p> <p>Switching arrangement no. 007 Contact material: silver-tin oxide</p> <p style="text-align: right;">10056E00</p>	13	23	0°		90°	X X	14	24	8006 / 4-007-00						
	13	23														
	0°															
	90°	X X														
	14	24														
	<table border="1" style="display: inline-table; margin-right: 20px;"> <tr><td>13</td><td>21</td></tr> <tr><td>0°</td><td></td></tr> <tr><td>90°</td><td>X X</td></tr> <tr><td>14</td><td>22</td></tr> </table>  <p>052</p> <p>Switching arrangement no. 052 Contact material: silver-tin oxide</p> <p style="text-align: right;">14645E00</p>	13	21	0°		90°	X X	14	22	8006 / 4-052-00						
	13	21														
0°																
90°	X X															
14	22															
<table border="1" style="display: inline-table; margin-right: 20px;"> <tr><td>13</td><td>23</td></tr> <tr><td>45°</td><td>X</td></tr> <tr><td>90°</td><td></td></tr> <tr><td>135°</td><td>X</td></tr> <tr><td>14</td><td>24</td></tr> </table>  <p>110</p> <p>Switching arrangement no. 110 Contact material: silver-tin oxide</p> <p style="text-align: right;">14666E00</p>	13	23	45°	X	90°		135°	X	14	24	8006 / 4-110-00					
13	23															
45°	X															
90°																
135°	X															
14	24															
<p>3-pole</p> <table border="1" style="display: inline-table; margin-right: 20px;"> <tr><td>13</td><td>23</td><td>33</td></tr> <tr><td>0°</td><td></td><td></td></tr> <tr><td>90°</td><td>X X X</td><td></td></tr> <tr><td>14</td><td>24</td><td>34</td></tr> </table>  <p>045</p> <p>Switching arrangement no. 045 Contact material: silver-tin oxide</p> <p style="text-align: right;">08889E00</p>	13	23	33	0°			90°	X X X		14	24	34	8006 / 4-045-00			
13	23	33														
0°																
90°	X X X															
14	24	34														
<table border="1" style="display: inline-table; margin-right: 20px;"> <tr><td>1</td><td>3</td><td>5</td></tr> <tr><td>45°</td><td></td><td></td></tr> <tr><td>135°</td><td>X X X</td><td></td></tr> <tr><td>2</td><td>4</td><td>6</td></tr> </table>  <p>082</p> <p>Switching arrangement no. 082 Contact material: silver-tin oxide</p> <p style="text-align: right;">08898E00</p>	1	3	5	45°			135°	X X X		2	4	6	8006 / 4-082-00			
1	3	5														
45°																
135°	X X X															
2	4	6														
<table border="1" style="display: inline-table; margin-right: 20px;"> <tr><td>1</td><td>3</td><td>5</td></tr> <tr><td>90°</td><td></td><td></td></tr> <tr><td>180°</td><td>X X X</td><td></td></tr> <tr><td>2</td><td>4</td><td>6</td></tr> </table>  <p>122</p> <p>Switching arrangement no. 122 Safety switch Safety switch Contact material: silver-tin oxide</p> <p style="text-align: right;">10083E00</p>	1	3	5	90°			180°	X X X		2	4	6	8006 / 4-122-00			
1	3	5														
90°																
180°	X X X															
2	4	6														
<table border="1" style="display: inline-table; margin-right: 20px;"> <tr><td>1</td><td>3</td><td>5</td></tr> <tr><td>90°</td><td></td><td></td></tr> <tr><td>180°</td><td>X X X</td><td></td></tr> <tr><td>2</td><td>4</td><td>6</td></tr> </table>  <p>122</p> <p>Switching arrangement no. 122 Safety switch Safety switch With N-terminal at the base Contact material: silver-tin oxide</p> <p style="text-align: right;">10083E00</p>	1	3	5	90°			180°	X X X		2	4	6	8006 / 4-122-20			
1	3	5														
90°																
180°	X X X															
2	4	6														
<table border="1" style="display: inline-table; margin-right: 20px;"> <tr><td>1</td><td>3</td><td>5</td></tr> <tr><td>90°</td><td></td><td></td></tr> <tr><td>180°</td><td>X X X</td><td></td></tr> <tr><td>2</td><td>4</td><td>6</td></tr> </table>  <p>122</p> <p>Switching arrangement no. 122 Safety switch Safety switch With earth terminal and N-terminal at the base Contact material: silver-tin oxide</p> <p style="text-align: right;">10083E00</p>	1	3	5	90°			180°	X X X		2	4	6	8006 / 4-122-30			
1	3	5														
90°																
180°	X X X															
2	4	6														
<table border="1" style="display: inline-table; margin-right: 20px;"> <tr><td>11</td><td>23</td><td>33</td></tr> <tr><td>0°</td><td>X</td><td></td></tr> <tr><td>90°</td><td></td><td>X</td></tr> <tr><td>180°</td><td></td><td>X</td></tr> <tr><td>12</td><td>24</td><td>34</td></tr> </table>  <p>154</p> <p>Switching arrangement no. 154 Contact material: gold-plated</p> <p style="text-align: right;">14667E00</p>	11	23	33	0°	X		90°		X	180°		X	12	24	34	8006 / 4-154-08
11	23	33														
0°	X															
90°		X														
180°		X														
12	24	34														

Load and Motor Switch / Control Switch

Series 8006/4

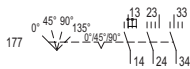
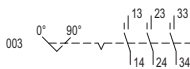
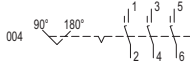
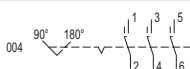
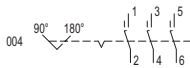
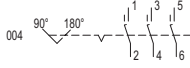
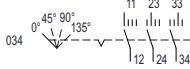
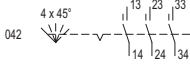

Selection Table

Version	Description	Order number																			
 <p>14792E00 Load and motor switch 25 A Series 8006/4</p>	<p>3-pole</p> <table border="1"> <tr><td>0°</td><td></td><td></td><td></td></tr> <tr><td>45°</td><td>X</td><td></td><td>X</td></tr> <tr><td>90°</td><td>X</td><td></td><td>X</td></tr> <tr><td>135°</td><td>X</td><td>X</td><td></td></tr> </table> <p>13 23 33 14 24 34</p>  <p>177</p> <p>Switching arrangement no. 177 Contact material: gold-plated</p> <p>10820E00</p>	0°				45°	X		X	90°	X		X	135°	X	X		8006/4-177-08			
	0°																				
	45°	X		X																	
	90°	X		X																	
	135°	X	X																		
	<p>4-pole</p> <table border="1"> <tr><td>0°</td><td></td><td></td><td></td><td></td></tr> <tr><td>90°</td><td>X</td><td>X</td><td>X</td><td>X</td></tr> </table> <p>13 23 33 43 14 24 34 44</p>  <p>003</p> <p>Switching arrangement no. 003 Contact material: silver-tin oxide</p> <p>08891E00</p>	0°					90°	X	X	X	X	8006/4-003-00									
	0°																				
	90°	X	X	X	X																
<table border="1"> <tr><td>90°</td><td></td><td></td><td></td><td></td></tr> <tr><td>180°</td><td>X</td><td>X</td><td>X</td><td>X</td></tr> </table> <p>1 3 5 13 2 4 6 14</p>  <p>004</p> <p>Switching arrangement no. 004 Safety switch Safety switch Contact material: silver-tin oxide</p> <p>10058E00</p>	90°					180°	X	X	X	X	8006/4-004-00										
90°																					
180°	X	X	X	X																	
<table border="1"> <tr><td>90°</td><td></td><td></td><td></td><td></td></tr> <tr><td>180°</td><td>X</td><td>X</td><td>X</td><td>X</td></tr> </table> <p>1 3 5 13 2 4 6 14</p>  <p>004</p> <p>Switching arrangement no. 004 Safety switch Safety switch With earth terminal at the base Contact material: silver-tin oxide</p> <p>10058E00</p>	90°					180°	X	X	X	X	8006/4-004-10										
90°																					
180°	X	X	X	X																	
<table border="1"> <tr><td>90°</td><td></td><td></td><td></td><td></td></tr> <tr><td>180°</td><td>X</td><td>X</td><td>X</td><td>X</td></tr> </table> <p>1 3 5 13 2 4 6 14</p>  <p>004</p> <p>Switching arrangement no. 004 Safety switch Safety switch With N-terminal at the base Contact material: silver-tin oxide</p> <p>10058E00</p>	90°					180°	X	X	X	X	8006/4-004-20										
90°																					
180°	X	X	X	X																	
<table border="1"> <tr><td>90°</td><td></td><td></td><td></td><td></td></tr> <tr><td>180°</td><td>X</td><td>X</td><td>X</td><td>X</td></tr> </table> <p>1 3 5 13 2 4 6 14</p>  <p>004</p> <p>Switching arrangement no. 004 Safety switch Safety switch With earth terminal and N-terminal at the base Contact material: silver-tin oxide</p> <p>10058E00</p>	90°					180°	X	X	X	X	8006/4-004-30										
90°																					
180°	X	X	X	X																	
<table border="1"> <tr><td>0°</td><td>X</td><td></td><td></td></tr> <tr><td>45°</td><td></td><td>X</td><td></td></tr> <tr><td>90°</td><td></td><td></td><td>X</td></tr> <tr><td>135°</td><td></td><td></td><td>X</td></tr> </table> <p>11 23 33 43 12 24 34 44</p>  <p>034</p> <p>Switching arrangement no. 034 Contact material: silver-tin oxide</p> <p>08892E00</p>	0°	X			45°		X		90°			X	135°			X	8006/4-034-00				
0°	X																				
45°		X																			
90°			X																		
135°			X																		
<table border="1"> <tr><td>0°</td><td></td><td></td><td></td></tr> <tr><td>45°</td><td>X</td><td></td><td></td></tr> <tr><td>90°</td><td></td><td>X</td><td></td></tr> <tr><td>135°</td><td></td><td></td><td>X</td></tr> <tr><td>180°</td><td></td><td></td><td>X</td></tr> </table> <p>13 23 33 43 14 24 34 44</p>  <p>042</p> <p>Switching arrangement no. 042 Contact material: silver-tin oxide</p> <p>06084E00</p>	0°				45°	X			90°		X		135°			X	180°			X	8006/4-042-00
0°																					
45°	X																				
90°		X																			
135°			X																		
180°			X																		

E9

Load and Motor Switch / Control Switch

Series 8006/4

Selection Table

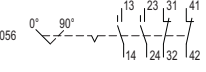
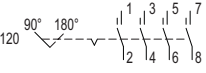
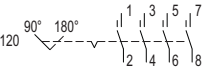
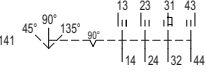
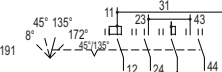
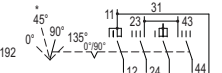
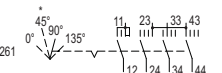
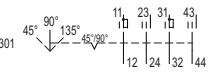



Version	Description	Order number																													
 <p>14792E00 Load and motor switch 25 A Series 8006/4</p>	<p>4-pole</p> <table border="1"> <tr><td></td><td>13</td><td>23</td><td>31</td><td>41</td></tr> <tr><td>0°</td><td></td><td></td><td>X</td><td>X</td></tr> <tr><td>90°</td><td>X</td><td>X</td><td></td><td></td></tr> <tr><td></td><td>14</td><td>24</td><td>32</td><td>42</td></tr> </table>  <p>056</p> <p>Switching arrangement no. 056 Contact material: silver-tin oxide</p> <p>14668E00</p>		13	23	31	41	0°			X	X	90°	X	X				14	24	32	42	8006 / 4-056-00									
		13	23	31	41																										
	0°			X	X																										
	90°	X	X																												
		14	24	32	42																										
	<table border="1"> <tr><td></td><td>1</td><td>3</td><td>5</td><td>7</td></tr> <tr><td>90°</td><td></td><td></td><td></td><td></td></tr> <tr><td>180°</td><td>X</td><td>X</td><td>X</td><td>X</td></tr> <tr><td></td><td>2</td><td>4</td><td>6</td><td>8</td></tr> </table>  <p>120</p> <p>Switching arrangement no. 120 Safety switch Safety switch Contact material: silver-tin oxide</p> <p>10081E00</p>		1	3	5	7	90°					180°	X	X	X	X		2	4	6	8	8006 / 4-120-00									
		1	3	5	7																										
	90°																														
180°	X	X	X	X																											
	2	4	6	8																											
<table border="1"> <tr><td></td><td>1</td><td>3</td><td>5</td><td>7</td></tr> <tr><td>90°</td><td></td><td></td><td></td><td></td></tr> <tr><td>180°</td><td>X</td><td>X</td><td>X</td><td>X</td></tr> <tr><td></td><td>2</td><td>4</td><td>6</td><td>8</td></tr> </table>  <p>120</p> <p>Switching arrangement no. 120 Safety switch Safety switch With earth terminal at the base Contact material: silver-tin oxide</p> <p>10081E00</p>		1	3	5	7	90°					180°	X	X	X	X		2	4	6	8	8006 / 4-120-10										
	1	3	5	7																											
90°																															
180°	X	X	X	X																											
	2	4	6	8																											
<table border="1"> <tr><td></td><td>13</td><td>23</td><td>31</td><td>43</td></tr> <tr><td>45°</td><td>X</td><td>X</td><td></td><td></td></tr> <tr><td>90°</td><td></td><td></td><td>X</td><td></td></tr> <tr><td>135°</td><td></td><td></td><td>X</td><td>X</td></tr> <tr><td></td><td>14</td><td>24</td><td>32</td><td>44</td></tr> </table>  <p>141</p> <p>Switching arrangement no. 141 Contact material: silver-tin oxide</p> <p>14669E00</p>		13	23	31	43	45°	X	X			90°			X		135°			X	X		14	24	32	44	8006 / 4-141-00					
	13	23	31	43																											
45°	X	X																													
90°			X																												
135°			X	X																											
	14	24	32	44																											
<table border="1"> <tr><td></td><td>11</td><td>23</td><td>31</td><td>43</td></tr> <tr><td>8°</td><td></td><td></td><td></td><td></td></tr> <tr><td>45°</td><td>X</td><td></td><td></td><td>X</td></tr> <tr><td>135°</td><td>X</td><td>X</td><td></td><td></td></tr> <tr><td>172°</td><td>X</td><td>X</td><td>X</td><td></td></tr> <tr><td></td><td>12</td><td>24</td><td>32</td><td>44</td></tr> </table>  <p>191</p> <p>Switching arrangement no. 191 Contact material: silver-tin oxide</p> <p>10091E00</p>		11	23	31	43	8°					45°	X			X	135°	X	X			172°	X	X	X			12	24	32	44	8006 / 4-191-00
	11	23	31	43																											
8°																															
45°	X			X																											
135°	X	X																													
172°	X	X	X																												
	12	24	32	44																											
<table border="1"> <tr><td></td><td>11</td><td>23</td><td>31</td><td>43</td></tr> <tr><td>0°</td><td>X</td><td></td><td></td><td>X</td></tr> <tr><td>45°</td><td></td><td></td><td>X</td><td></td></tr> <tr><td>90°</td><td>X</td><td>X</td><td></td><td></td></tr> <tr><td>135°</td><td>X</td><td>X</td><td>X</td><td></td></tr> <tr><td></td><td>12</td><td>24</td><td>32</td><td>44</td></tr> </table>  <p>192</p> <p>Switching arrangement no. 192 * pressure point Contact material: silver-tin oxide</p> <p>10092E00</p>		11	23	31	43	0°	X			X	45°			X		90°	X	X			135°	X	X	X			12	24	32	44	8006 / 4-192-00
	11	23	31	43																											
0°	X			X																											
45°			X																												
90°	X	X																													
135°	X	X	X																												
	12	24	32	44																											
<table border="1"> <tr><td></td><td>11</td><td>23</td><td>33</td><td>43</td></tr> <tr><td>0°</td><td>X</td><td></td><td></td><td>X</td></tr> <tr><td>45°</td><td></td><td></td><td>X</td><td></td></tr> <tr><td>90°</td><td>X</td><td>X</td><td></td><td></td></tr> <tr><td>135°</td><td>X</td><td>X</td><td>X</td><td></td></tr> <tr><td></td><td>12</td><td>24</td><td>34</td><td>44</td></tr> </table>  <p>261</p> <p>Switching arrangement no. 261 * pressure point Contact material: silver-tin oxide</p> <p>10094E00</p>		11	23	33	43	0°	X			X	45°			X		90°	X	X			135°	X	X	X			12	24	34	44	8006 / 4-261-00
	11	23	33	43																											
0°	X			X																											
45°			X																												
90°	X	X																													
135°	X	X	X																												
	12	24	34	44																											
<table border="1"> <tr><td></td><td>11</td><td>23</td><td>31</td><td>43</td></tr> <tr><td>45°</td><td></td><td></td><td></td><td></td></tr> <tr><td>90°</td><td>X</td><td>X</td><td></td><td></td></tr> <tr><td>135°</td><td>X</td><td>X</td><td>X</td><td>X</td></tr> <tr><td></td><td>12</td><td>24</td><td>32</td><td>44</td></tr> </table>  <p>301</p> <p>Switching arrangement no. 301 Contact material: silver-tin oxide</p> <p>10822E00</p>		11	23	31	43	45°					90°	X	X			135°	X	X	X	X		12	24	32	44	8006 / 4-301-00					
	11	23	31	43																											
45°																															
90°	X	X																													
135°	X	X	X	X																											
	12	24	32	44																											

Load and Motor Switch / Control Switch

Series 8006/4

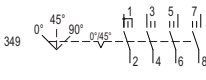
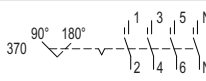
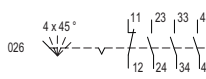
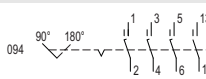
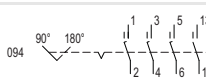

Selection Table

Version	Description	Order number																																									
 <p>14792E00 Load and motor switch 25 A Series 8006/4</p>	<p>4-pole</p> <table border="1"> <tr><td></td><td>1</td><td>3</td><td>5</td><td>7</td></tr> <tr><td>0°</td><td>X</td><td>X</td><td></td><td></td></tr> <tr><td>45°</td><td></td><td></td><td></td><td></td></tr> <tr><td>90°</td><td>X</td><td></td><td>X</td><td>X</td></tr> <tr><td></td><td>2</td><td>4</td><td>6</td><td>8</td></tr> </table> <p>Switching arrangement no. 349 Contact material: silver-tin oxide</p>  <p>14676E00</p>		1	3	5	7	0°	X	X			45°					90°	X		X	X		2	4	6	8	8006/4-349-00																
		1	3	5	7																																						
	0°	X	X																																								
	45°																																										
	90°	X		X	X																																						
		2	4	6	8																																						
	<table border="1"> <tr><td></td><td>1</td><td>3</td><td>5</td><td>N</td></tr> <tr><td>90°</td><td></td><td></td><td></td><td></td></tr> <tr><td>180°</td><td>X</td><td>X</td><td>X</td><td>X</td></tr> <tr><td></td><td>2</td><td>4</td><td>6</td><td>N'</td></tr> </table> <p>Switching arrangement no. 370 Contact material: silver-tin oxide</p>  <p>16516E00</p>		1	3	5	N	90°					180°	X	X	X	X		2	4	6	N'	8006/4-370-00																					
	1	3	5	N																																							
90°																																											
180°	X	X	X	X																																							
	2	4	6	N'																																							
<p>5-pole</p> <table border="1"> <tr><td></td><td>11</td><td>23</td><td>33</td><td>43</td><td>53</td></tr> <tr><td>0°</td><td>X</td><td></td><td></td><td></td><td></td></tr> <tr><td>45°</td><td></td><td>X</td><td></td><td></td><td></td></tr> <tr><td>90°</td><td></td><td></td><td>X</td><td></td><td></td></tr> <tr><td>135°</td><td></td><td></td><td></td><td>X</td><td></td></tr> <tr><td>180°</td><td></td><td></td><td></td><td></td><td>X</td></tr> <tr><td></td><td>12</td><td>24</td><td>34</td><td>44</td><td>54</td></tr> </table> <p>Switching arrangement no. 026 Contact material: silver-tin oxide</p>  <p>10076E00</p>		11	23	33	43	53	0°	X					45°		X				90°			X			135°				X		180°					X		12	24	34	44	54	8006/4-026-00
	11	23	33	43	53																																						
0°	X																																										
45°		X																																									
90°			X																																								
135°				X																																							
180°					X																																						
	12	24	34	44	54																																						
<table border="1"> <tr><td></td><td>1</td><td>3</td><td>5</td><td>13</td><td>21</td></tr> <tr><td>90°</td><td></td><td></td><td></td><td></td><td>X</td></tr> <tr><td>180°</td><td>X</td><td>X</td><td>X</td><td>X</td><td>X</td></tr> <tr><td></td><td>2</td><td>4</td><td>6</td><td>14</td><td>22</td></tr> </table> <p>Switching arrangement no. 094 Safety switch Safety switch Contact material: silver-tin oxide</p>  <p>10077E00</p>		1	3	5	13	21	90°					X	180°	X	X	X	X	X		2	4	6	14	22	8006/4-094-00																		
	1	3	5	13	21																																						
90°					X																																						
180°	X	X	X	X	X																																						
	2	4	6	14	22																																						
<table border="1"> <tr><td></td><td>1</td><td>3</td><td>5</td><td>13</td><td>21</td></tr> <tr><td>90°</td><td></td><td></td><td></td><td></td><td>X</td></tr> <tr><td>180°</td><td>X</td><td>X</td><td>X</td><td>X</td><td>X</td></tr> <tr><td></td><td>2</td><td>4</td><td>6</td><td>14</td><td>22</td></tr> </table> <p>Switching arrangement no. 094 Safety switch Safety switch With earth terminal at the base Contact material: silver-tin oxide</p>  <p>10077E00</p>		1	3	5	13	21	90°					X	180°	X	X	X	X	X		2	4	6	14	22	8006/4-094-10																		
	1	3	5	13	21																																						
90°					X																																						
180°	X	X	X	X	X																																						
	2	4	6	14	22																																						
<table border="1"> <tr><td></td><td>1</td><td>3</td><td>5</td><td>13</td><td>23</td></tr> <tr><td>90°</td><td></td><td></td><td></td><td></td><td>X</td></tr> <tr><td>180°</td><td>X</td><td>X</td><td>X</td><td>X</td><td>X</td></tr> <tr><td></td><td>2</td><td>4</td><td>6</td><td>14</td><td>24</td></tr> </table> <p>Switching arrangement no. 099 Safety switch Safety switch Contact material: silver-tin oxide</p>  <p>10078E00</p>		1	3	5	13	23	90°					X	180°	X	X	X	X	X		2	4	6	14	24	8006/4-099-00																		
	1	3	5	13	23																																						
90°					X																																						
180°	X	X	X	X	X																																						
	2	4	6	14	24																																						
<table border="1"> <tr><td></td><td>1</td><td>3</td><td>5</td><td>13</td><td>23</td></tr> <tr><td>90°</td><td></td><td></td><td></td><td></td><td>X</td></tr> <tr><td>180°</td><td>X</td><td>X</td><td>X</td><td>X</td><td>X</td></tr> <tr><td></td><td>2</td><td>4</td><td>6</td><td>14</td><td>24</td></tr> </table> <p>Switching arrangement no. 099 Safety switch Safety switch With earth terminal at the base Contact material: silver-tin oxide</p>  <p>10078E00</p>		1	3	5	13	23	90°					X	180°	X	X	X	X	X		2	4	6	14	24	8006/4-099-10																		
	1	3	5	13	23																																						
90°					X																																						
180°	X	X	X	X	X																																						
	2	4	6	14	24																																						
<table border="1"> <tr><td></td><td>1</td><td>3</td><td>5</td><td>13</td><td>23</td></tr> <tr><td>90°</td><td></td><td></td><td></td><td></td><td>X</td></tr> <tr><td>180°</td><td>X</td><td>X</td><td>X</td><td>X</td><td>X</td></tr> <tr><td></td><td>2</td><td>4</td><td>6</td><td>14</td><td>24</td></tr> </table> <p>Switching arrangement no. 099 Safety switch Safety switch Contact material: silver-tin oxide</p>  <p>10078E00</p>		1	3	5	13	23	90°					X	180°	X	X	X	X	X		2	4	6	14	24	8006/4-099-20																		
	1	3	5	13	23																																						
90°					X																																						
180°	X	X	X	X	X																																						
	2	4	6	14	24																																						

E9

Load and Motor Switch / Control Switch

Series 8006/4

Selection Table

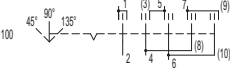
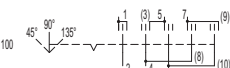
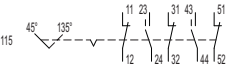
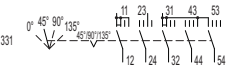
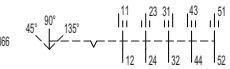
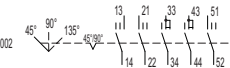
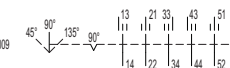
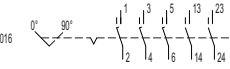
Version	Description	Order number																																				
 <p>14792E00 Load and motor switch 25 A Series 8006/4</p>	5-pole <table border="1" style="display: inline-table; margin-right: 20px;"> <tr><td></td><td>1</td><td>(3)</td><td>5</td><td>7</td><td>(9)</td></tr> <tr><td>45°</td><td>X</td><td>X</td><td>X</td><td>X</td><td></td></tr> <tr><td>90°</td><td></td><td></td><td></td><td></td><td></td></tr> <tr><td>135°</td><td>X</td><td>X</td><td></td><td>X</td><td></td></tr> <tr><td></td><td>2</td><td>4</td><td>6</td><td>(8)</td><td>(10)</td></tr> </table>  <p>100</p>		1	(3)	5	7	(9)	45°	X	X	X	X		90°						135°	X	X		X			2	4	6	(8)	(10)	8006 / 4-100-00 10079E00						
		1	(3)	5	7	(9)																																
	45°	X	X	X	X																																	
	90°																																					
	135°	X	X		X																																	
		2	4	6	(8)	(10)																																
	Switching arrangement no. 100 Reversing switch Contact material: silver-tin oxide	<table border="1" style="display: inline-table; margin-right: 20px;"> <tr><td></td><td>1</td><td>(3)</td><td>5</td><td>7</td><td>(9)</td></tr> <tr><td>45°</td><td>X</td><td>X</td><td>X</td><td>X</td><td></td></tr> <tr><td>90°</td><td></td><td></td><td></td><td></td><td></td></tr> <tr><td>135°</td><td>X</td><td>X</td><td></td><td>X</td><td></td></tr> <tr><td></td><td>2</td><td>4</td><td>6</td><td>(8)</td><td>(10)</td></tr> </table>  <p>100</p>		1	(3)	5	7	(9)	45°	X	X	X	X		90°						135°	X	X		X			2	4	6	(8)	(10)	8006 / 4-100-20 10079E00					
		1	(3)	5	7	(9)																																
	45°	X	X	X	X																																	
90°																																						
135°	X	X		X																																		
	2	4	6	(8)	(10)																																	
Switching arrangement no. 100 Reversing switch With N-terminal at the base Contact material: silver-tin oxide	<table border="1" style="display: inline-table; margin-right: 20px;"> <tr><td></td><td>11</td><td>23</td><td>31</td><td>43</td><td>51</td></tr> <tr><td>45°</td><td>X</td><td>X</td><td>X</td><td>X</td><td></td></tr> <tr><td>135°</td><td>X</td><td>X</td><td></td><td>X</td><td></td></tr> <tr><td></td><td>12</td><td>24</td><td>32</td><td>44</td><td>52</td></tr> </table>  <p>115</p>		11	23	31	43	51	45°	X	X	X	X		135°	X	X		X			12	24	32	44	52	8006 / 4-115-00 14950E00												
	11	23	31	43	51																																	
45°	X	X	X	X																																		
135°	X	X		X																																		
	12	24	32	44	52																																	
Switching arrangement no. 115 Contact material: silver-tin oxide	<table border="1" style="display: inline-table; margin-right: 20px;"> <tr><td></td><td>11</td><td>23</td><td>31</td><td>43</td><td>53</td></tr> <tr><td>0°</td><td>X</td><td>X</td><td>X</td><td>X</td><td></td></tr> <tr><td>45°</td><td>X</td><td></td><td></td><td></td><td></td></tr> <tr><td>90°</td><td>X</td><td></td><td></td><td></td><td></td></tr> <tr><td>135°</td><td>X</td><td></td><td></td><td></td><td>X</td></tr> <tr><td></td><td>12</td><td>24</td><td>32</td><td>44</td><td>54</td></tr> </table>  <p>331</p>		11	23	31	43	53	0°	X	X	X	X		45°	X					90°	X					135°	X				X		12	24	32	44	54	8006 / 4-331-00 10096E00
	11	23	31	43	53																																	
0°	X	X	X	X																																		
45°	X																																					
90°	X																																					
135°	X				X																																	
	12	24	32	44	54																																	
Switching arrangement no. 331 Contact material: silver-tin oxide	<table border="1" style="display: inline-table; margin-right: 20px;"> <tr><td></td><td>11</td><td>23</td><td>31</td><td>43</td><td>51</td></tr> <tr><td>45°</td><td>X</td><td></td><td></td><td></td><td></td></tr> <tr><td>90°</td><td></td><td>X</td><td>X</td><td>X</td><td>X</td></tr> <tr><td>135°</td><td>X</td><td></td><td></td><td></td><td></td></tr> <tr><td></td><td>12</td><td>24</td><td>32</td><td>44</td><td>52</td></tr> </table>  <p>366</p>		11	23	31	43	51	45°	X					90°		X	X	X	X	135°	X						12	24	32	44	52	8006 / 4-366-00 16521E00						
	11	23	31	43	51																																	
45°	X																																					
90°		X	X	X	X																																	
135°	X																																					
	12	24	32	44	52																																	
Switching arrangement no. 366 Contact material: silver-tin oxide	6-pole <table border="1" style="display: inline-table; margin-right: 20px;"> <tr><td></td><td>13</td><td>21</td><td>33</td><td>43</td><td>51</td><td>61</td></tr> <tr><td>45°</td><td>X</td><td>X</td><td></td><td>X</td><td>X</td><td></td></tr> <tr><td>90°</td><td></td><td>X</td><td>X</td><td></td><td>X</td><td></td></tr> <tr><td>135°</td><td>X</td><td>X</td><td>X</td><td></td><td>X</td><td></td></tr> <tr><td></td><td>14</td><td>22</td><td>34</td><td>44</td><td>52</td><td>62</td></tr> </table>  <p>002</p>		13	21	33	43	51	61	45°	X	X		X	X		90°		X	X		X		135°	X	X	X		X			14	22	34	44	52	62	8006 / 4-002-00 14951E00	
	13	21	33	43	51	61																																
45°	X	X		X	X																																	
90°		X	X		X																																	
135°	X	X	X		X																																	
	14	22	34	44	52	62																																
Switching arrangement no. 002 Contact material: silver-tin oxide	<table border="1" style="display: inline-table; margin-right: 20px;"> <tr><td></td><td>13</td><td>21</td><td>33</td><td>43</td><td>51</td><td>63</td></tr> <tr><td>45°</td><td>X</td><td></td><td></td><td>X</td><td></td><td></td></tr> <tr><td>90°</td><td>X</td><td></td><td></td><td>X</td><td></td><td></td></tr> <tr><td>135°</td><td></td><td>X</td><td>X</td><td></td><td>X</td><td></td></tr> <tr><td></td><td>14</td><td>22</td><td>34</td><td>44</td><td>52</td><td>64</td></tr> </table>  <p>009</p>		13	21	33	43	51	63	45°	X			X			90°	X			X			135°		X	X		X			14	22	34	44	52	64	8006 / 4-009-00 10061E00	
	13	21	33	43	51	63																																
45°	X			X																																		
90°	X			X																																		
135°		X	X		X																																	
	14	22	34	44	52	64																																
Switching arrangement no. 009 Contact material: silver-tin oxide	<table border="1" style="display: inline-table; margin-right: 20px;"> <tr><td></td><td>1</td><td>3</td><td>5</td><td>13</td><td>23</td><td>33</td></tr> <tr><td>0°</td><td>X</td><td>X</td><td>X</td><td>X</td><td>X</td><td>X</td></tr> <tr><td>90°</td><td>X</td><td>X</td><td>X</td><td>X</td><td>X</td><td>X</td></tr> <tr><td></td><td>2</td><td>4</td><td>6</td><td>14</td><td>24</td><td>34</td></tr> </table>  <p>016</p>		1	3	5	13	23	33	0°	X	X	X	X	X	X	90°	X	X	X	X	X	X		2	4	6	14	24	34	8006 / 4-016-00 10062E00								
	1	3	5	13	23	33																																
0°	X	X	X	X	X	X																																
90°	X	X	X	X	X	X																																
	2	4	6	14	24	34																																
Switching arrangement no. 016 Safety switch Safety switch Contact material: silver-tin oxide																																						

Load and Motor Switch / Control Switch

Series 8006/4

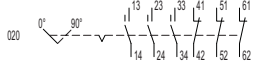
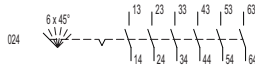
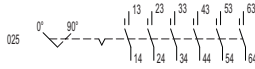
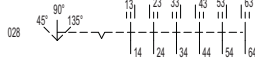
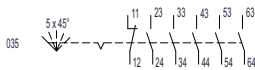
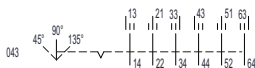
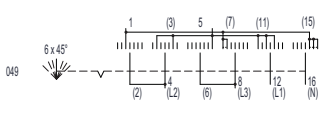
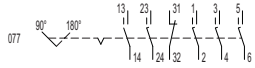

Selection Table

Version	Description	Order number																																																																					
 <p>14792E00 Load and motor switch 25 A Series 8006/4</p>	<p>6-pole</p> <table border="1"> <tr><td></td><td>13</td><td>23</td><td>33</td><td>41</td><td>51</td><td>61</td></tr> <tr><td>0°</td><td></td><td></td><td></td><td>X</td><td>X</td><td>X</td></tr> <tr><td>90°</td><td>X</td><td>X</td><td>X</td><td>X</td><td>X</td><td>X</td></tr> <tr><td></td><td>14</td><td>24</td><td>34</td><td>42</td><td>52</td><td>62</td></tr> </table> <p>Switching arrangement no. 020 Contact material: silver-tin oxide</p>  <p>10063E00</p>		13	23	33	41	51	61	0°				X	X	X	90°	X	X	X	X	X	X		14	24	34	42	52	62	8006/4-020-00																																									
		13	23	33	41	51	61																																																																
	0°				X	X	X																																																																
	90°	X	X	X	X	X	X																																																																
		14	24	34	42	52	62																																																																
	<table border="1"> <tr><td></td><td>13</td><td>23</td><td>33</td><td>43</td><td>53</td><td>63</td></tr> <tr><td>0°</td><td></td><td></td><td></td><td></td><td></td><td></td></tr> <tr><td>45°</td><td>X</td><td></td><td></td><td></td><td></td><td></td></tr> <tr><td>90°</td><td></td><td>X</td><td></td><td></td><td></td><td></td></tr> <tr><td>135°</td><td></td><td></td><td>X</td><td></td><td></td><td></td></tr> <tr><td>180°</td><td></td><td></td><td></td><td>X</td><td></td><td></td></tr> <tr><td>225°</td><td></td><td></td><td></td><td></td><td>X</td><td></td></tr> <tr><td>270°</td><td></td><td></td><td></td><td></td><td></td><td>X</td></tr> <tr><td></td><td>14</td><td>24</td><td>34</td><td>44</td><td>54</td><td>64</td></tr> </table> <p>Switching arrangement no. 024 Contact material: silver-tin oxide</p>  <p>08893E00</p>		13	23	33	43	53	63	0°							45°	X						90°		X					135°			X				180°				X			225°					X		270°						X		14	24	34	44	54	64	8006/4-024-00						
		13	23	33	43	53	63																																																																
	0°																																																																						
45°	X																																																																						
90°		X																																																																					
135°			X																																																																				
180°				X																																																																			
225°					X																																																																		
270°						X																																																																	
	14	24	34	44	54	64																																																																	
<table border="1"> <tr><td></td><td>13</td><td>23</td><td>33</td><td>43</td><td>53</td><td>63</td></tr> <tr><td>0°</td><td></td><td></td><td></td><td></td><td></td><td></td></tr> <tr><td>90°</td><td>X</td><td>X</td><td>X</td><td>X</td><td>X</td><td>X</td></tr> <tr><td></td><td>14</td><td>24</td><td>34</td><td>44</td><td>54</td><td>64</td></tr> </table> <p>Switching arrangement no. 025 Contact material: silver-tin oxide</p>  <p>14952E00</p>		13	23	33	43	53	63	0°							90°	X	X	X	X	X	X		14	24	34	44	54	64	8006/4-025-00																																										
	13	23	33	43	53	63																																																																	
0°																																																																							
90°	X	X	X	X	X	X																																																																	
	14	24	34	44	54	64																																																																	
<table border="1"> <tr><td></td><td>13</td><td>23</td><td>33</td><td>43</td><td>53</td><td>63</td></tr> <tr><td>45°</td><td></td><td>X</td><td></td><td>X</td><td></td><td>X</td></tr> <tr><td>90°</td><td></td><td></td><td>X</td><td></td><td>X</td><td></td></tr> <tr><td>135°</td><td>X</td><td></td><td>X</td><td></td><td>X</td><td></td></tr> <tr><td></td><td>14</td><td>24</td><td>34</td><td>44</td><td>54</td><td>64</td></tr> </table> <p>Switching arrangement no. 028 Contact material: silver-tin oxide</p>  <p>04647E00</p>		13	23	33	43	53	63	45°		X		X		X	90°			X		X		135°	X		X		X			14	24	34	44	54	64	8006/4-028-00																																			
	13	23	33	43	53	63																																																																	
45°		X		X		X																																																																	
90°			X		X																																																																		
135°	X		X		X																																																																		
	14	24	34	44	54	64																																																																	
<table border="1"> <tr><td></td><td>11</td><td>23</td><td>33</td><td>43</td><td>53</td><td>63</td></tr> <tr><td>0°</td><td>X</td><td></td><td></td><td></td><td></td><td></td></tr> <tr><td>45°</td><td></td><td>X</td><td></td><td></td><td></td><td></td></tr> <tr><td>90°</td><td></td><td></td><td>X</td><td></td><td></td><td></td></tr> <tr><td>135°</td><td></td><td></td><td></td><td>X</td><td></td><td></td></tr> <tr><td>180°</td><td></td><td></td><td></td><td></td><td>X</td><td></td></tr> <tr><td>225°</td><td></td><td></td><td></td><td></td><td></td><td>X</td></tr> <tr><td></td><td>12</td><td>24</td><td>34</td><td>44</td><td>54</td><td>64</td></tr> </table> <p>Switching arrangement no. 035 Contact material: silver-tin oxide</p>  <p>04678E00</p>		11	23	33	43	53	63	0°	X						45°		X					90°			X				135°				X			180°					X		225°						X		12	24	34	44	54	64	8006/4-035-00														
	11	23	33	43	53	63																																																																	
0°	X																																																																						
45°		X																																																																					
90°			X																																																																				
135°				X																																																																			
180°					X																																																																		
225°						X																																																																	
	12	24	34	44	54	64																																																																	
<table border="1"> <tr><td></td><td>13</td><td>21</td><td>33</td><td>43</td><td>51</td><td>63</td></tr> <tr><td>45°</td><td>X</td><td></td><td></td><td>X</td><td></td><td></td></tr> <tr><td>90°</td><td></td><td>X</td><td></td><td>X</td><td></td><td></td></tr> <tr><td>135°</td><td></td><td></td><td>X</td><td></td><td>X</td><td></td></tr> <tr><td></td><td>14</td><td>22</td><td>34</td><td>44</td><td>52</td><td>64</td></tr> </table> <p>Switching arrangement no. 043 Contact material: silver-tin oxide</p>  <p>06087E00</p>		13	21	33	43	51	63	45°	X			X			90°		X		X			135°			X		X			14	22	34	44	52	64	8006/4-043-00																																			
	13	21	33	43	51	63																																																																	
45°	X			X																																																																			
90°		X		X																																																																			
135°			X		X																																																																		
	14	22	34	44	52	64																																																																	
<table border="1"> <tr><td></td><td>1</td><td>(3)</td><td>5</td><td>(7)</td><td>(11)</td><td>(15)</td></tr> <tr><td>315°</td><td></td><td></td><td></td><td>X</td><td></td><td></td></tr> <tr><td>0°</td><td></td><td>X</td><td></td><td></td><td>X</td><td></td></tr> <tr><td>45°</td><td>X</td><td></td><td></td><td></td><td></td><td>X</td></tr> <tr><td>90°</td><td></td><td></td><td></td><td></td><td></td><td></td></tr> <tr><td>135°</td><td></td><td></td><td></td><td>X</td><td></td><td>X</td></tr> <tr><td>180°</td><td>X</td><td></td><td></td><td></td><td></td><td></td></tr> <tr><td>225°</td><td></td><td></td><td>X</td><td></td><td></td><td>X</td></tr> <tr><td></td><td>(2)</td><td>4</td><td>(6)</td><td>8</td><td>12</td><td>16</td></tr> <tr><td></td><td></td><td>(L2)</td><td></td><td>(L3)</td><td>(L1)</td><td>(N)</td></tr> </table> <p>Switching arrangement no. 049 Voltmeter selector switch Contact material: silver-tin oxide</p>  <p>06089E00</p>		1	(3)	5	(7)	(11)	(15)	315°				X			0°		X			X		45°	X					X	90°							135°				X		X	180°	X						225°			X			X		(2)	4	(6)	8	12	16			(L2)		(L3)	(L1)	(N)	8006/4-049-00
	1	(3)	5	(7)	(11)	(15)																																																																	
315°				X																																																																			
0°		X			X																																																																		
45°	X					X																																																																	
90°																																																																							
135°				X		X																																																																	
180°	X																																																																						
225°			X			X																																																																	
	(2)	4	(6)	8	12	16																																																																	
		(L2)		(L3)	(L1)	(N)																																																																	
<table border="1"> <tr><td></td><td>13</td><td>23</td><td>31</td><td>1</td><td>3</td><td>5</td></tr> <tr><td>90°</td><td></td><td></td><td>X</td><td></td><td>X</td><td></td></tr> <tr><td>180°</td><td>X</td><td>X</td><td>X</td><td>X</td><td>X</td><td>X</td></tr> <tr><td></td><td>14</td><td>24</td><td>32</td><td>2</td><td>4</td><td>6</td></tr> </table> <p>Switching arrangement no. 077 Safety switch Safety switch Contact material: silver-tin oxide</p>  <p>06896E00</p>		13	23	31	1	3	5	90°			X		X		180°	X	X	X	X	X	X		14	24	32	2	4	6	8006/4-077-00																																										
	13	23	31	1	3	5																																																																	
90°			X		X																																																																		
180°	X	X	X	X	X	X																																																																	
	14	24	32	2	4	6																																																																	

E9

Load and Motor Switch / Control Switch

Series 8006/4

Selection Table

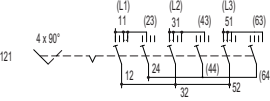
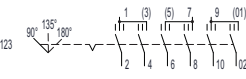
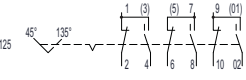
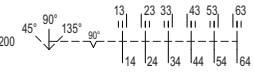
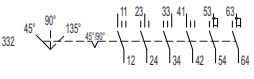
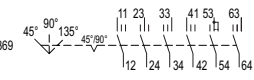
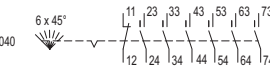

Version	Description	Order number																																
 <p>14792E00 Load and motor switch 25 A Series 8006/4</p>	<p>6-pole</p> <table border="1"> <tr> <td></td> <td>(L1)</td> <td>(L2)</td> <td>(L3)</td> </tr> <tr> <td></td> <td>11 (23)</td> <td>31 (43)</td> <td>51 (63)</td> </tr> <tr> <td>0°/90°</td> <td>X</td> <td>X</td> <td>X</td> </tr> <tr> <td>90°</td> <td>X</td> <td>X</td> <td>X</td> </tr> <tr> <td>180°</td> <td>X</td> <td>X</td> <td>X</td> </tr> <tr> <td>270°</td> <td>X</td> <td>X</td> <td>X</td> </tr> <tr> <td>0°/90°</td> <td>X</td> <td>X</td> <td>X</td> </tr> <tr> <td></td> <td>12 24 32 (44) 52 (64)</td> <td></td> <td></td> </tr> </table>  <p>121</p> <p>10082E00</p> <p>Switching arrangement no. 121 Ammeter selector switch with OFF-position for 3 transformers Contact material: silver-tin oxide</p>		(L1)	(L2)	(L3)		11 (23)	31 (43)	51 (63)	0°/90°	X	X	X	90°	X	X	X	180°	X	X	X	270°	X	X	X	0°/90°	X	X	X		12 24 32 (44) 52 (64)			8006 / 4-121-00
		(L1)	(L2)	(L3)																														
		11 (23)	31 (43)	51 (63)																														
	0°/90°	X	X	X																														
	90°	X	X	X																														
180°	X	X	X																															
270°	X	X	X																															
0°/90°	X	X	X																															
	12 24 32 (44) 52 (64)																																	
<table border="1"> <tr> <td></td> <td>1 (3)</td> <td>(5)</td> <td>7</td> <td>9 (01)</td> </tr> <tr> <td>90°</td> <td>X</td> <td>X</td> <td>X</td> <td>X</td> </tr> <tr> <td>135°</td> <td>X</td> <td>X</td> <td>X</td> <td>X</td> </tr> <tr> <td>180°</td> <td>X</td> <td>X</td> <td>X</td> <td>X</td> </tr> <tr> <td></td> <td>2 4 6 8 10 02</td> <td></td> <td></td> <td></td> </tr> </table>  <p>123</p> <p>10084E00</p> <p>Switching arrangement no. 123 Pol-changing switch with OFF-position With N-terminal at the base Contact material: silver-tin oxide</p>		1 (3)	(5)	7	9 (01)	90°	X	X	X	X	135°	X	X	X	X	180°	X	X	X	X		2 4 6 8 10 02				8006 / 4-123-20								
	1 (3)	(5)	7	9 (01)																														
90°	X	X	X	X																														
135°	X	X	X	X																														
180°	X	X	X	X																														
	2 4 6 8 10 02																																	
<table border="1"> <tr> <td></td> <td>1 (3)</td> <td>(5)</td> <td>7</td> <td>9 (01)</td> </tr> <tr> <td>45°</td> <td>X</td> <td>X</td> <td>X</td> <td>X</td> </tr> <tr> <td>135°</td> <td>X</td> <td>X</td> <td>X</td> <td>X</td> </tr> <tr> <td></td> <td>2 4 6 8 10 02</td> <td></td> <td></td> <td></td> </tr> </table>  <p>125</p> <p>10086E00</p> <p>Switching arrangement no. 125 Change-over switch without OFF-position With N-terminal at the base Contact material: silver-tin oxide</p>		1 (3)	(5)	7	9 (01)	45°	X	X	X	X	135°	X	X	X	X		2 4 6 8 10 02				8006 / 4-125-20													
	1 (3)	(5)	7	9 (01)																														
45°	X	X	X	X																														
135°	X	X	X	X																														
	2 4 6 8 10 02																																	
<table border="1"> <tr> <td></td> <td>13 23 33</td> <td>43 53 63</td> </tr> <tr> <td>45°</td> <td>X</td> <td>X</td> </tr> <tr> <td>90°</td> <td>X</td> <td>X</td> </tr> <tr> <td>135°</td> <td>X</td> <td>X</td> </tr> <tr> <td></td> <td>14 24 34 44 54 64</td> <td></td> </tr> </table>  <p>200</p> <p>14953E00</p> <p>Switching arrangement no. 200 Contact material: silver-tin oxide</p>		13 23 33	43 53 63	45°	X	X	90°	X	X	135°	X	X		14 24 34 44 54 64		8006 / 4-200-00																		
	13 23 33	43 53 63																																
45°	X	X																																
90°	X	X																																
135°	X	X																																
	14 24 34 44 54 64																																	
<table border="1"> <tr> <td></td> <td>11 23 33</td> <td>41 53 63</td> </tr> <tr> <td>45°</td> <td>X</td> <td>X</td> </tr> <tr> <td>90°</td> <td>X</td> <td>X</td> </tr> <tr> <td>135°</td> <td>X</td> <td>X</td> </tr> <tr> <td></td> <td>12 24 34 42 54 64</td> <td></td> </tr> </table>  <p>332</p> <p>10097E00</p> <p>Switching arrangement no. 332 Contact material: silver-tin oxide</p>		11 23 33	41 53 63	45°	X	X	90°	X	X	135°	X	X		12 24 34 42 54 64		8006 / 4-332-00																		
	11 23 33	41 53 63																																
45°	X	X																																
90°	X	X																																
135°	X	X																																
	12 24 34 42 54 64																																	
<table border="1"> <tr> <td></td> <td>11 23 33</td> <td>41 53 63</td> </tr> <tr> <td>0°</td> <td>X</td> <td>X</td> </tr> <tr> <td>90°</td> <td>X</td> <td>X</td> </tr> <tr> <td>135°</td> <td>X</td> <td>X</td> </tr> <tr> <td></td> <td>12 24 34 42 54 64</td> <td></td> </tr> </table>  <p>369</p> <p>15466E00</p> <p>Switching arrangement no. 369 Contact material: silver-tin oxide</p>		11 23 33	41 53 63	0°	X	X	90°	X	X	135°	X	X		12 24 34 42 54 64		8006 / 4-369-00																		
	11 23 33	41 53 63																																
0°	X	X																																
90°	X	X																																
135°	X	X																																
	12 24 34 42 54 64																																	
<p>7-pole</p> <table border="1"> <tr> <td></td> <td>11 23 33</td> <td>43 53 63 73</td> </tr> <tr> <td>0°</td> <td>X</td> <td>X</td> </tr> <tr> <td>45°</td> <td>X</td> <td>X</td> </tr> <tr> <td>90°</td> <td>X</td> <td>X</td> </tr> <tr> <td>135°</td> <td>X</td> <td>X</td> </tr> <tr> <td>180°</td> <td>X</td> <td>X</td> </tr> <tr> <td>225°</td> <td>X</td> <td>X</td> </tr> <tr> <td>270°</td> <td>X</td> <td>X</td> </tr> <tr> <td></td> <td>12 24 34 44 54 64 74</td> <td></td> </tr> </table>  <p>040</p> <p>04785E00</p> <p>Switching arrangement no. 040 Contact material: silver-tin oxide</p>		11 23 33	43 53 63 73	0°	X	X	45°	X	X	90°	X	X	135°	X	X	180°	X	X	225°	X	X	270°	X	X		12 24 34 44 54 64 74		8006 / 4-040-00						
	11 23 33	43 53 63 73																																
0°	X	X																																
45°	X	X																																
90°	X	X																																
135°	X	X																																
180°	X	X																																
225°	X	X																																
270°	X	X																																
	12 24 34 44 54 64 74																																	

Load and Motor Switch / Control Switch

Series 8006/4

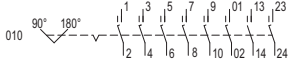
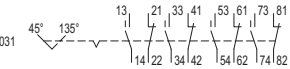
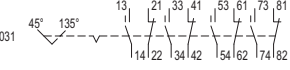
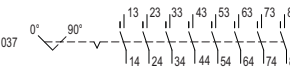
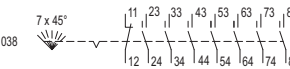
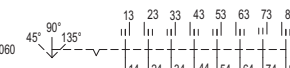

Selection Table

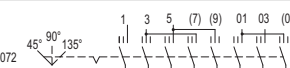



Version	Description	Order number																																																															
 <p>14792E00 Load and motor switch 25 A Series 8006/4</p>	<p>8-pole</p> <table border="1"> <tr><td>90°</td><td>X</td><td>X</td><td>X</td><td>X</td><td>X</td><td>X</td><td>X</td></tr> <tr><td>180°</td><td>X</td><td>X</td><td>X</td><td>X</td><td>X</td><td>X</td><td>X</td></tr> </table> <p>1 3 5 7 9 01 13 23 2 4 6 8 10 02 14 24</p>  <p>010</p> <p>Switching arrangement no. 010 Safety switch Safety switch Contact material: silver-tin oxide</p> <p>10075E00</p>	90°	X	X	X	X	X	X	X	180°	X	X	X	X	X	X	X	8006/4-010-00																																															
	90°	X	X	X	X	X	X	X																																																									
	180°	X	X	X	X	X	X	X																																																									
	<table border="1"> <tr><td>45°</td><td>X</td><td>X</td><td>X</td><td>X</td><td>X</td><td>X</td><td>X</td></tr> <tr><td>135°</td><td>X</td><td>X</td><td>X</td><td>X</td><td>X</td><td>X</td><td>X</td></tr> </table> <p>13 21 33 41 53 61 73 81 14 22 34 42 54 62 74 82</p>  <p>031</p> <p>Switching arrangement no. 031 Contact material: silver-tin oxide</p> <p>04648E00</p>	45°	X	X	X	X	X	X	X	135°	X	X	X	X	X	X	X	8006/4-031-00																																															
	45°	X	X	X	X	X	X	X																																																									
	135°	X	X	X	X	X	X	X																																																									
	<table border="1"> <tr><td>45°</td><td>X</td><td>X</td><td>X</td><td>X</td><td>X</td><td>X</td><td>X</td></tr> <tr><td>135°</td><td>X</td><td>X</td><td>X</td><td>X</td><td>X</td><td>X</td><td>X</td></tr> </table> <p>13 21 33 41 53 61 73 81 14 22 34 42 54 62 74 82</p>  <p>031</p> <p>Switching arrangement no. 031 Contact material: gold-plated</p> <p>04648E00</p>	45°	X	X	X	X	X	X	X	135°	X	X	X	X	X	X	X	8006/4-031-08																																															
	45°	X	X	X	X	X	X	X																																																									
135°	X	X	X	X	X	X	X																																																										
<table border="1"> <tr><td>0°</td><td>X</td><td>X</td><td>X</td><td>X</td><td>X</td><td>X</td><td>X</td></tr> <tr><td>90°</td><td>X</td><td>X</td><td>X</td><td>X</td><td>X</td><td>X</td><td>X</td></tr> </table> <p>13 23 33 43 53 63 73 83 14 24 34 44 54 64 74 84</p>  <p>037</p> <p>Switching arrangement no. 037 Contact material: silver-tin oxide</p> <p>14954E00</p>	0°	X	X	X	X	X	X	X	90°	X	X	X	X	X	X	X	8006/4-037-00																																																
0°	X	X	X	X	X	X	X																																																										
90°	X	X	X	X	X	X	X																																																										
<table border="1"> <tr><td>0°</td><td>X</td><td></td><td></td><td></td><td></td><td></td><td></td></tr> <tr><td>45°</td><td>X</td><td></td><td></td><td></td><td></td><td></td><td></td></tr> <tr><td>90°</td><td></td><td>X</td><td></td><td></td><td></td><td></td><td></td></tr> <tr><td>135°</td><td></td><td></td><td>X</td><td></td><td></td><td></td><td></td></tr> <tr><td>180°</td><td></td><td></td><td></td><td>X</td><td></td><td></td><td></td></tr> <tr><td>225°</td><td></td><td></td><td></td><td></td><td>X</td><td></td><td></td></tr> <tr><td>270°</td><td></td><td></td><td></td><td></td><td></td><td>X</td><td></td></tr> <tr><td>315°</td><td></td><td></td><td></td><td></td><td></td><td></td><td>X</td></tr> </table> <p>11 23 33 43 53 63 73 83 12 24 34 44 54 64 74 84</p>  <p>038</p> <p>Switching arrangement no. 038 Contact material: silver-tin oxide</p> <p>06082E00</p>	0°	X							45°	X							90°		X						135°			X					180°				X				225°					X			270°						X		315°							X	8006/4-038-00
0°	X																																																																
45°	X																																																																
90°		X																																																															
135°			X																																																														
180°				X																																																													
225°					X																																																												
270°						X																																																											
315°							X																																																										
<table border="1"> <tr><td>45°</td><td>X</td><td>X</td><td>X</td><td>X</td><td>X</td><td>X</td><td>X</td></tr> <tr><td>90°</td><td>X</td><td>X</td><td>X</td><td>X</td><td>X</td><td>X</td><td>X</td></tr> <tr><td>135°</td><td>X</td><td>X</td><td>X</td><td>X</td><td>X</td><td>X</td><td>X</td></tr> </table> <p>13 23 33 43 53 63 73 83 14 24 34 44 54 64 74 84</p>  <p>060</p> <p>Switching arrangement no. 060 Contact material: silver-tin oxide</p> <p>06090E00</p>	45°	X	X	X	X	X	X	X	90°	X	X	X	X	X	X	X	135°	X	X	X	X	X	X	X	8006/4-060-00																																								
45°	X	X	X	X	X	X	X																																																										
90°	X	X	X	X	X	X	X																																																										
135°	X	X	X	X	X	X	X																																																										
<table border="1"> <tr><td>0°</td><td>X</td><td></td><td></td><td>X</td><td></td><td></td><td></td></tr> <tr><td>45°</td><td>X</td><td></td><td></td><td>X</td><td></td><td></td><td></td></tr> <tr><td>90°</td><td></td><td>X</td><td></td><td>X</td><td></td><td></td><td></td></tr> <tr><td>135°</td><td></td><td></td><td>X</td><td>X</td><td></td><td></td><td>X</td></tr> </table> <p>11 23 33 43 51 63 73 83 12 24 34 44 52 64 74 84</p>  <p>061</p> <p>Switching arrangement no. 061 Contact material: silver-tin oxide</p> <p>08894E00</p>	0°	X			X				45°	X			X				90°		X		X				135°			X	X			X	8006/4-061-00																																
0°	X			X																																																													
45°	X			X																																																													
90°		X		X																																																													
135°			X	X			X																																																										
<table border="1"> <tr><td>0°</td><td></td><td></td><td></td><td></td><td></td><td></td><td></td></tr> <tr><td>45°</td><td>X</td><td></td><td>X</td><td></td><td></td><td></td><td>X</td></tr> <tr><td>90°</td><td>X</td><td>X</td><td>X</td><td>X</td><td>X</td><td>X</td><td>X</td></tr> </table> <p>1 3 5 (7) (9) 01 03 (05) (2) 4 6 8 (10) (02) 04 (06)</p>  <p>072</p> <p>Switching arrangement no. 072 "Dahlanderschalter" Contact material: silver-tin oxide</p> <p>08895E00</p>	0°								45°	X		X				X	90°	X	X	X	X	X	X	X	8006/4-072-00																																								
0°																																																																	
45°	X		X				X																																																										
90°	X	X	X	X	X	X	X																																																										

E9

Load and Motor Switch / Control Switch

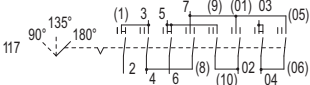
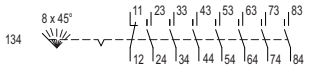
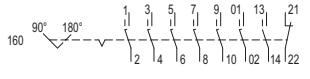
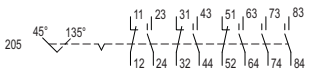
Series 8006/4

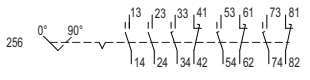
Selection Table

Version	Description	Order number																																																																																																		
 <p>14792E00 Load and motor switch 25 A Series 8006/4</p>	<p>8-pole</p> <table border="1"> <tr><td></td><td>(1)</td><td>3</td><td>5</td><td>7</td><td>(9)</td><td>(01)</td><td>03</td><td>(05)</td></tr> <tr><td>90°</td><td></td><td></td><td></td><td></td><td></td><td></td><td></td><td></td></tr> <tr><td>135°</td><td>X</td><td>X</td><td>X</td><td>X</td><td>X</td><td>X</td><td>X</td><td>X</td></tr> <tr><td>180°</td><td>X</td><td>X</td><td>X</td><td>X</td><td>X</td><td>X</td><td>X</td><td>X</td></tr> <tr><td></td><td>2</td><td>4</td><td>6</td><td>(8)</td><td>(10)</td><td>02</td><td>04</td><td>(06)</td></tr> </table>  <p>10080E00</p> <p>Switching arrangement no. 117 Star-delta switch Contact material: silver-tin oxide</p>		(1)	3	5	7	(9)	(01)	03	(05)	90°									135°	X	X	X	X	X	X	X	X	180°	X	X	X	X	X	X	X	X		2	4	6	(8)	(10)	02	04	(06)	8006/4-117-20																																																					
		(1)	3	5	7	(9)	(01)	03	(05)																																																																																											
	90°																																																																																																			
	135°	X	X	X	X	X	X	X	X																																																																																											
	180°	X	X	X	X	X	X	X	X																																																																																											
		2	4	6	(8)	(10)	02	04	(06)																																																																																											
<table border="1"> <tr><td>0/360°</td><td>X</td><td></td><td></td><td></td><td></td><td></td><td></td><td></td></tr> <tr><td>45°</td><td>X</td><td></td><td></td><td></td><td></td><td></td><td></td><td></td></tr> <tr><td>90°</td><td></td><td>X</td><td></td><td></td><td></td><td></td><td></td><td></td></tr> <tr><td>135°</td><td></td><td></td><td>X</td><td></td><td></td><td></td><td></td><td></td></tr> <tr><td>180°</td><td></td><td></td><td></td><td>X</td><td></td><td></td><td></td><td></td></tr> <tr><td>225°</td><td></td><td></td><td></td><td></td><td>X</td><td></td><td></td><td></td></tr> <tr><td>270°</td><td></td><td></td><td></td><td></td><td></td><td>X</td><td></td><td></td></tr> <tr><td>315°</td><td></td><td></td><td></td><td></td><td></td><td></td><td>X</td><td></td></tr> <tr><td></td><td>11</td><td>23</td><td>33</td><td>43</td><td>53</td><td>63</td><td>73</td><td>83</td></tr> <tr><td></td><td>12</td><td>24</td><td>34</td><td>44</td><td>54</td><td>64</td><td>74</td><td>84</td></tr> </table>  <p>14955E00</p> <p>Switching arrangement no. 134 Contact material: silver-tin oxide</p>	0/360°	X								45°	X								90°		X							135°			X						180°				X					225°					X				270°						X			315°							X			11	23	33	43	53	63	73	83		12	24	34	44	54	64	74	84	8006/4-134-00									
0/360°	X																																																																																																			
45°	X																																																																																																			
90°		X																																																																																																		
135°			X																																																																																																	
180°				X																																																																																																
225°					X																																																																																															
270°						X																																																																																														
315°							X																																																																																													
	11	23	33	43	53	63	73	83																																																																																												
	12	24	34	44	54	64	74	84																																																																																												
<table border="1"> <tr><td></td><td>1</td><td>3</td><td>5</td><td>7</td><td>9</td><td>01</td><td>13</td><td>21</td></tr> <tr><td>90°</td><td>X</td><td>X</td><td>X</td><td>X</td><td>X</td><td>X</td><td>X</td><td>X</td></tr> <tr><td>180°</td><td>X</td><td>X</td><td>X</td><td>X</td><td>X</td><td>X</td><td>X</td><td>X</td></tr> <tr><td></td><td>2</td><td>4</td><td>6</td><td>8</td><td>10</td><td>02</td><td>14</td><td>22</td></tr> </table>  <p>10089E00</p> <p>Switching arrangement no. 160 Safety switch Safety switch Contact material: silver-tin oxide</p>		1	3	5	7	9	01	13	21	90°	X	X	X	X	X	X	X	X	180°	X	X	X	X	X	X	X	X		2	4	6	8	10	02	14	22	8006/4-160-00																																																															
	1	3	5	7	9	01	13	21																																																																																												
90°	X	X	X	X	X	X	X	X																																																																																												
180°	X	X	X	X	X	X	X	X																																																																																												
	2	4	6	8	10	02	14	22																																																																																												
<table border="1"> <tr><td></td><td>11</td><td>23</td><td>31</td><td>43</td><td>51</td><td>63</td><td>73</td><td>83</td></tr> <tr><td>45°</td><td>X</td><td>X</td><td>X</td><td>X</td><td>X</td><td>X</td><td>X</td><td>X</td></tr> <tr><td>135°</td><td>X</td><td>X</td><td>X</td><td>X</td><td>X</td><td>X</td><td>X</td><td>X</td></tr> <tr><td></td><td>12</td><td>24</td><td>32</td><td>44</td><td>52</td><td>64</td><td>74</td><td>84</td></tr> </table>  <p>14956E00</p> <p>Switching arrangement no. 205 Contact material: silver-tin oxide</p>		11	23	31	43	51	63	73	83	45°	X	X	X	X	X	X	X	X	135°	X	X	X	X	X	X	X	X		12	24	32	44	52	64	74	84	8006/4-205-00																																																															
	11	23	31	43	51	63	73	83																																																																																												
45°	X	X	X	X	X	X	X	X																																																																																												
135°	X	X	X	X	X	X	X	X																																																																																												
	12	24	32	44	52	64	74	84																																																																																												
<table border="1"> <tr><td></td><td>11</td><td>23</td><td>33</td><td>41</td><td>53</td><td>61</td><td>73</td><td>81</td></tr> <tr><td>0°</td><td>X</td><td></td><td>X</td><td></td><td>X</td><td></td><td>X</td><td></td></tr> <tr><td>45°</td><td>X</td><td>X</td><td></td><td>X</td><td>X</td><td></td><td>X</td><td>X</td></tr> <tr><td>90°</td><td>X</td><td></td><td>X</td><td></td><td>X</td><td></td><td>X</td><td></td></tr> <tr><td>135°</td><td>X</td><td>X</td><td></td><td>X</td><td>X</td><td></td><td>X</td><td>X</td></tr> <tr><td></td><td>12</td><td>24</td><td>34</td><td>42</td><td>54</td><td>62</td><td>74</td><td>82</td></tr> </table>  <p>15464E00</p> <p>Switching arrangement no. 216 Contact material: silver-tin oxide</p>		11	23	33	41	53	61	73	81	0°	X		X		X		X		45°	X	X		X	X		X	X	90°	X		X		X		X		135°	X	X		X	X		X	X		12	24	34	42	54	62	74	82	8006/4-216-00																																													
	11	23	33	41	53	61	73	81																																																																																												
0°	X		X		X		X																																																																																													
45°	X	X		X	X		X	X																																																																																												
90°	X		X		X		X																																																																																													
135°	X	X		X	X		X	X																																																																																												
	12	24	34	42	54	62	74	82																																																																																												
<table border="1"> <tr><td></td><td>13</td><td>23</td><td>33</td><td>43</td><td>53</td><td>63</td><td>73</td><td>83</td></tr> <tr><td>0°</td><td></td><td></td><td></td><td></td><td></td><td></td><td></td><td></td></tr> <tr><td>30°</td><td>X</td><td></td><td></td><td></td><td></td><td></td><td></td><td></td></tr> <tr><td>60°</td><td>X</td><td></td><td></td><td></td><td></td><td></td><td></td><td></td></tr> <tr><td>90°</td><td></td><td>X</td><td></td><td></td><td></td><td></td><td></td><td></td></tr> <tr><td>120°</td><td></td><td></td><td>X</td><td></td><td></td><td></td><td></td><td></td></tr> <tr><td>150°</td><td></td><td></td><td></td><td>X</td><td></td><td></td><td></td><td></td></tr> <tr><td>180°</td><td></td><td></td><td></td><td></td><td>X</td><td></td><td></td><td></td></tr> <tr><td>210°</td><td></td><td></td><td></td><td></td><td></td><td>X</td><td></td><td></td></tr> <tr><td>240°</td><td></td><td></td><td></td><td></td><td></td><td></td><td>X</td><td></td></tr> <tr><td></td><td>14</td><td>24</td><td>34</td><td>44</td><td>54</td><td>64</td><td>74</td><td>84</td></tr> </table>  <p>10823E00</p> <p>Switching arrangement no. 238 Contact material: silver-tin oxide</p>		13	23	33	43	53	63	73	83	0°									30°	X								60°	X								90°		X							120°			X						150°				X					180°					X				210°						X			240°							X			14	24	34	44	54	64	74	84	8006/4-238-00
	13	23	33	43	53	63	73	83																																																																																												
0°																																																																																																				
30°	X																																																																																																			
60°	X																																																																																																			
90°		X																																																																																																		
120°			X																																																																																																	
150°				X																																																																																																
180°					X																																																																																															
210°						X																																																																																														
240°							X																																																																																													
	14	24	34	44	54	64	74	84																																																																																												
<table border="1"> <tr><td></td><td>13</td><td>23</td><td>33</td><td>41</td><td>53</td><td>61</td><td>73</td><td>81</td></tr> <tr><td>0°</td><td>X</td><td>X</td><td>X</td><td>X</td><td>X</td><td>X</td><td>X</td><td>X</td></tr> <tr><td>90°</td><td>X</td><td>X</td><td>X</td><td>X</td><td>X</td><td>X</td><td>X</td><td>X</td></tr> <tr><td></td><td>14</td><td>24</td><td>34</td><td>42</td><td>54</td><td>62</td><td>74</td><td>82</td></tr> </table>  <p>14957E00</p> <p>Switching arrangement no. 256 Contact material: gold-plated</p>		13	23	33	41	53	61	73	81	0°	X	X	X	X	X	X	X	X	90°	X	X	X	X	X	X	X	X		14	24	34	42	54	62	74	82	8006/4-256-00																																																															
	13	23	33	41	53	61	73	81																																																																																												
0°	X	X	X	X	X	X	X	X																																																																																												
90°	X	X	X	X	X	X	X	X																																																																																												
	14	24	34	42	54	62	74	82																																																																																												
<table border="1"> <tr><td></td><td>1</td><td>3</td><td>5</td><td>7</td><td>9</td><td>11</td><td>13</td><td>15</td></tr> <tr><td>45°</td><td>X</td><td>X</td><td>X</td><td>X</td><td></td><td></td><td></td><td></td></tr> <tr><td>90°</td><td></td><td></td><td></td><td></td><td>X</td><td>X</td><td>X</td><td></td></tr> <tr><td>135°</td><td></td><td></td><td></td><td></td><td>X</td><td>X</td><td>X</td><td></td></tr> <tr><td></td><td>2</td><td>4</td><td>6</td><td>8</td><td>10</td><td>12</td><td>14</td><td>16</td></tr> </table>  <p>14958E00</p> <p>Switching arrangement no. 361 Contact material: silver-tin oxide</p>		1	3	5	7	9	11	13	15	45°	X	X	X	X					90°					X	X	X		135°					X	X	X			2	4	6	8	10	12	14	16	8006/4-361-00																																																						
	1	3	5	7	9	11	13	15																																																																																												
45°	X	X	X	X																																																																																																
90°					X	X	X																																																																																													
135°					X	X	X																																																																																													
	2	4	6	8	10	12	14	16																																																																																												

Load and Motor Switch / Control Switch

Series 8006/4



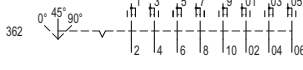
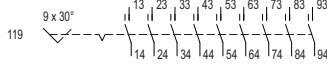
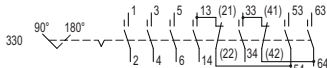
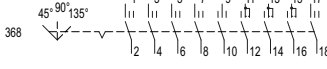
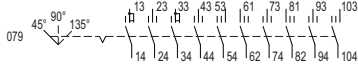
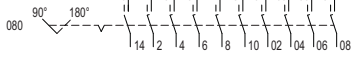
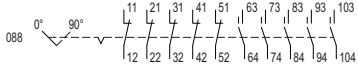
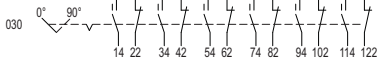
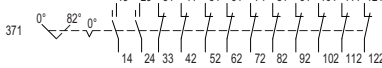

Selection Table

Version	Description	Order number																																																																																																													
 <p>14792E00 Load and motor switch 25 A Series 8006/4</p>	<p>8-pole</p> <table border="1"> <tr><td></td><td>1</td><td>3</td><td>5</td><td>7</td><td>9</td><td>01</td><td>03</td><td>05</td></tr> <tr><td>0°</td><td>X</td><td>X</td><td>X</td><td>X</td><td>X</td><td>X</td><td>X</td><td>X</td></tr> <tr><td>45°</td><td>X</td><td>X</td><td>X</td><td>X</td><td>X</td><td>X</td><td>X</td><td>X</td></tr> <tr><td>90°</td><td>X</td><td>X</td><td>X</td><td>X</td><td>X</td><td>X</td><td>X</td><td>X</td></tr> </table> <p>2 4 6 8 10 02 04 06</p>  <p>362</p> <p>Switching arrangement no. 362 Contact material: silver-tin oxide</p> <p>14959E00</p>		1	3	5	7	9	01	03	05	0°	X	X	X	X	X	X	X	X	45°	X	X	X	X	X	X	X	X	90°	X	X	X	X	X	X	X	X	8006/4-362-00																																																																									
		1	3	5	7	9	01	03	05																																																																																																						
	0°	X	X	X	X	X	X	X	X																																																																																																						
45°	X	X	X	X	X	X	X	X																																																																																																							
90°	X	X	X	X	X	X	X	X																																																																																																							
<p>9-pole</p> <table border="1"> <tr><td></td><td>13</td><td>23</td><td>33</td><td>43</td><td>53</td><td>63</td><td>73</td><td>83</td><td>93</td></tr> <tr><td>0°</td><td></td><td></td><td></td><td></td><td></td><td></td><td></td><td></td><td></td></tr> <tr><td>30°</td><td>X</td><td></td><td></td><td></td><td></td><td></td><td></td><td></td><td></td></tr> <tr><td>60°</td><td>X</td><td></td><td></td><td></td><td></td><td></td><td></td><td></td><td></td></tr> <tr><td>90°</td><td></td><td>X</td><td></td><td></td><td></td><td></td><td></td><td></td><td></td></tr> <tr><td>120°</td><td></td><td></td><td>X</td><td></td><td></td><td></td><td></td><td></td><td></td></tr> <tr><td>150°</td><td></td><td></td><td></td><td>X</td><td></td><td></td><td></td><td></td><td></td></tr> <tr><td>180°</td><td></td><td></td><td></td><td></td><td>X</td><td></td><td></td><td></td><td></td></tr> <tr><td>210°</td><td></td><td></td><td></td><td></td><td></td><td>X</td><td></td><td></td><td></td></tr> <tr><td>240°</td><td></td><td></td><td></td><td></td><td></td><td></td><td>X</td><td></td><td></td></tr> <tr><td>270°</td><td></td><td></td><td></td><td></td><td></td><td></td><td></td><td>X</td><td></td></tr> </table> <p>14 24 34 44 54 64 74 84 94</p>  <p>119</p> <p>Switching arrangement no. 119 Contact material: silver-tin oxide</p> <p>14960E00</p>		13	23	33	43	53	63	73	83	93	0°										30°	X									60°	X									90°		X								120°			X							150°				X						180°					X					210°						X				240°							X			270°								X		8006/4-119-00
	13	23	33	43	53	63	73	83	93																																																																																																						
0°																																																																																																															
30°	X																																																																																																														
60°	X																																																																																																														
90°		X																																																																																																													
120°			X																																																																																																												
150°				X																																																																																																											
180°					X																																																																																																										
210°						X																																																																																																									
240°							X																																																																																																								
270°								X																																																																																																							
<table border="1"> <tr><td></td><td>1</td><td>3</td><td>5</td><td>13</td><td>(21)</td><td>33</td><td>(41)</td><td>53</td><td>63</td></tr> <tr><td>90°</td><td></td><td></td><td></td><td>X</td><td></td><td>X</td><td></td><td>X</td><td></td></tr> <tr><td>180°</td><td>X</td><td>X</td><td>X</td><td>X</td><td>X</td><td>X</td><td>X</td><td>X</td><td>X</td></tr> </table> <p>2 4 6 14 (22) 34 (42) 54 64</p>  <p>330</p> <p>Switching arrangement no. 330 Contact material: silver-tin oxide, auxiliary contacts: gold-plated</p> <p>10095E00</p>		1	3	5	13	(21)	33	(41)	53	63	90°				X		X		X		180°	X	X	X	X	X	X	X	X	X	8006/4-330-06																																																																																
	1	3	5	13	(21)	33	(41)	53	63																																																																																																						
90°				X		X		X																																																																																																							
180°	X	X	X	X	X	X	X	X	X																																																																																																						
<table border="1"> <tr><td></td><td>1</td><td>3</td><td>5</td><td>7</td><td>9</td><td>11</td><td>13</td><td>15</td><td>17</td></tr> <tr><td>0°</td><td>X</td><td>X</td><td>X</td><td>X</td><td></td><td></td><td></td><td></td><td>X</td></tr> <tr><td>45°</td><td></td><td></td><td></td><td></td><td>X</td><td>X</td><td>X</td><td>X</td><td></td></tr> <tr><td>90°</td><td></td><td></td><td></td><td></td><td>X</td><td>X</td><td>X</td><td>X</td><td></td></tr> </table> <p>2 4 6 8 10 12 14 16 18</p>  <p>368</p> <p>Switching arrangement no. 368 Contact material: silver-tin oxide</p> <p>15465E00</p>		1	3	5	7	9	11	13	15	17	0°	X	X	X	X					X	45°					X	X	X	X		90°					X	X	X	X		8006/4-368-00																																																																						
	1	3	5	7	9	11	13	15	17																																																																																																						
0°	X	X	X	X					X																																																																																																						
45°					X	X	X	X																																																																																																							
90°					X	X	X	X																																																																																																							
<p>10-pole</p> <table border="1"> <tr><td></td><td>13</td><td>23</td><td>33</td><td>43</td><td>53</td><td>61</td><td>73</td><td>81</td><td>93</td><td>103</td></tr> <tr><td>45°</td><td></td><td></td><td></td><td></td><td>X</td><td></td><td>X</td><td></td><td></td><td></td></tr> <tr><td>90°</td><td>X</td><td>X</td><td>X</td><td>X</td><td>X</td><td>X</td><td>X</td><td>X</td><td>X</td><td>X</td></tr> <tr><td>135°</td><td>X</td><td>X</td><td>X</td><td>X</td><td>X</td><td>X</td><td>X</td><td>X</td><td>X</td><td>X</td></tr> </table> <p>14 24 34 44 54 62 74 82 94 104</p>  <p>079</p> <p>Switching arrangement no. 079 Contact material: silver-tin oxide</p> <p>14961E00</p>		13	23	33	43	53	61	73	81	93	103	45°					X		X				90°	X	X	X	X	X	X	X	X	X	X	135°	X	X	X	X	X	X	X	X	X	X	8006/4-079-00																																																																		
	13	23	33	43	53	61	73	81	93	103																																																																																																					
45°					X		X																																																																																																								
90°	X	X	X	X	X	X	X	X	X	X																																																																																																					
135°	X	X	X	X	X	X	X	X	X	X																																																																																																					
<table border="1"> <tr><td></td><td>13</td><td>1</td><td>3</td><td>5</td><td>7</td><td>9</td><td>01</td><td>03</td><td>05</td><td>07</td></tr> <tr><td>90°</td><td>X</td><td>X</td><td>X</td><td>X</td><td>X</td><td>X</td><td>X</td><td>X</td><td>X</td><td>X</td></tr> <tr><td>180°</td><td>X</td><td>X</td><td>X</td><td>X</td><td>X</td><td>X</td><td>X</td><td>X</td><td>X</td><td>X</td></tr> </table> <p>14 2 4 6 8 10 02 04 06 08</p>  <p>080</p> <p>Switching arrangement no. 080 With earth terminal at the base Contact material: silver-tin oxide, auxiliary contacts: gold-plated</p> <p>08897E00</p>		13	1	3	5	7	9	01	03	05	07	90°	X	X	X	X	X	X	X	X	X	X	180°	X	X	X	X	X	X	X	X	X	X	8006/4-080-16																																																																													
	13	1	3	5	7	9	01	03	05	07																																																																																																					
90°	X	X	X	X	X	X	X	X	X	X																																																																																																					
180°	X	X	X	X	X	X	X	X	X	X																																																																																																					
<table border="1"> <tr><td></td><td>11</td><td>21</td><td>31</td><td>41</td><td>51</td><td>63</td><td>73</td><td>83</td><td>93</td><td>103</td></tr> <tr><td>0°</td><td>X</td><td>X</td><td>X</td><td>X</td><td>X</td><td></td><td></td><td></td><td></td><td></td></tr> <tr><td>90°</td><td>X</td><td>X</td><td>X</td><td>X</td><td>X</td><td>X</td><td>X</td><td>X</td><td>X</td><td>X</td></tr> </table> <p>12 22 32 42 52 64 74 84 94 104</p>  <p>088</p> <p>Switching arrangement no. 088 Contact material: silver-tin oxide</p> <p>10101E00</p>		11	21	31	41	51	63	73	83	93	103	0°	X	X	X	X	X						90°	X	X	X	X	X	X	X	X	X	X	8006/4-088-00																																																																													
	11	21	31	41	51	63	73	83	93	103																																																																																																					
0°	X	X	X	X	X																																																																																																										
90°	X	X	X	X	X	X	X	X	X	X																																																																																																					
<p>12-pole</p> <table border="1"> <tr><td></td><td>13</td><td>21</td><td>33</td><td>41</td><td>53</td><td>61</td><td>73</td><td>81</td><td>93</td><td>101</td><td>113</td><td>121</td></tr> <tr><td>0°</td><td>X</td><td>X</td><td>X</td><td>X</td><td>X</td><td>X</td><td>X</td><td>X</td><td>X</td><td>X</td><td>X</td><td>X</td></tr> <tr><td>90°</td><td>X</td><td>X</td><td>X</td><td>X</td><td>X</td><td>X</td><td>X</td><td>X</td><td>X</td><td>X</td><td>X</td><td>X</td></tr> </table> <p>14 22 34 42 53 62 74 82 94 102 114 122</p>  <p>030</p> <p>Switching arrangement no. 030 Contact material: silver-tin oxide</p> <p>14962E00</p>		13	21	33	41	53	61	73	81	93	101	113	121	0°	X	X	X	X	X	X	X	X	X	X	X	X	90°	X	X	X	X	X	X	X	X	X	X	X	X	8006/4-030-00																																																																							
	13	21	33	41	53	61	73	81	93	101	113	121																																																																																																			
0°	X	X	X	X	X	X	X	X	X	X	X	X																																																																																																			
90°	X	X	X	X	X	X	X	X	X	X	X	X																																																																																																			
<table border="1"> <tr><td></td><td>13</td><td>23</td><td>31</td><td>41</td><td>51</td><td>61</td><td>71</td><td>81</td><td>91</td><td>101</td><td>111</td><td>121</td></tr> <tr><td>0°</td><td></td><td></td><td>X</td><td>X</td><td>X</td><td>X</td><td>X</td><td>X</td><td>X</td><td>X</td><td>X</td><td>X</td></tr> <tr><td>82°</td><td>X</td><td>X</td><td></td><td></td><td></td><td></td><td></td><td></td><td></td><td></td><td></td><td></td></tr> </table> <p>14 24 33 42 52 62 72 82 92 102 112 122</p>  <p>371</p> <p>Switching arrangement no. 371 Contact material: silver-tin oxide</p> <p>16522E00</p>		13	23	31	41	51	61	71	81	91	101	111	121	0°			X	X	X	X	X	X	X	X	X	X	82°	X	X											8006/4-371-00																																																																							
	13	23	31	41	51	61	71	81	91	101	111	121																																																																																																			
0°			X	X	X	X	X	X	X	X	X	X																																																																																																			
82°	X	X																																																																																																													

E9

Load and Motor Switch / Control Switch

Series 8006/4

Explosion Protection																					
Global (IECEX)																					
Gas and dust	IECEX PTB 06.0018U Ex db eb IIC Gb Ex db eb I Mb																				
Europe (ATEX)																					
Gas and dust	PTB 01 ATEX 1021 U ⊕ II 2 G Ex db eb IIC Gb ⊕ I M2 Ex db eb I Mb																				
USA (UL)/Canada (UL)																					
Gas	 LISTED 4R27 US: Class I, Zone 1, AEx d e IIC T6 ... T5 (Class I, Div. 2, Groups ABCD) C: Class I, Zone 1, Ex d e IIC T6 ... T5 Gb (Class I, Div. 2 per CEC J18-150) T6 (Ta = -50 ... +50 °C) T5 (Ta = -50 ... +65 °C) T4 (Ta = -50 ... +70 °C)																				
USA (FM)/Canada (FM)																					
Gas	 3044997 US: Class I, Zone 1, AEx d e IIC T6 ... T5 (Class I, Div. 2, Groups ABCD) C: Class I, Zone 1, Ex d e IIC T6 ... T5 Gb (Class I, Div. 2 per CEC J18-150) T6 (Ta = -50 ... +40 °C) T5 (Ta = -50 ... +55 °C)																				
Certifications and certificates																					
Certificates	IECEX, ATEX, USA (FM, UL)																				
Technical Data																					
Version	IECEX / ATEX																				
Electrical data																					
Rated insulation voltage	max. 690 V AC																				
Rated frequency	50 / 60 Hz																				
Rated operational voltage	max. 690 V AC / 220 V DC (load and motor switch); 250 V DC (control switch) min. 24 V AC / DC (recommended for contact safety)																				
Rated impulse withstand voltage	6 kV																				
Rated operational current	max. 25 A min. 100 mA (recommended for contact safety: min. one switching operation per week)																				
Contacts	max. 12 pole / 6 switching levels *) *) The switches have two switching chambers per level. Individual switching levels with 1 or 2 contacts each to form a unit provide an optimal solution for individual applications. The contact chambers are being operated by the ratched wheels in a staggered fashion, thus enabling all around switching without interference.																				
Switching capacity	according to IEC/EN 60947-3; IEC/EN 60947-4-1; IEC/EN 60947-5-1: <table border="1"> <thead> <tr> <th>AC-3</th> <th>AC-15</th> <th>AC-23</th> <th>DC-1, DC-23</th> <th>DC-13 (L/R=300 ms)</th> </tr> </thead> <tbody> <tr> <td>690 V, 25 A</td> <td>400 V, 10 A</td> <td>690 V, 25 A</td> <td>220 V, 25 A³⁾</td> <td>250 V, 1.1 A¹⁾</td> </tr> <tr> <td></td> <td></td> <td></td> <td>120 V, 25 A²⁾</td> <td>125 V, 2.2 A¹⁾</td> </tr> <tr> <td></td> <td></td> <td></td> <td>60 V, 25 A¹⁾</td> <td>60 V, 5.0 A¹⁾</td> </tr> </tbody> </table> ¹⁾ 1 contact ²⁾ 2 contacts in series ³⁾ 3 contacts in series	AC-3	AC-15	AC-23	DC-1, DC-23	DC-13 (L/R=300 ms)	690 V, 25 A	400 V, 10 A	690 V, 25 A	220 V, 25 A ³⁾	250 V, 1.1 A ¹⁾				120 V, 25 A ²⁾	125 V, 2.2 A ¹⁾				60 V, 25 A ¹⁾	60 V, 5.0 A ¹⁾
AC-3	AC-15	AC-23	DC-1, DC-23	DC-13 (L/R=300 ms)																	
690 V, 25 A	400 V, 10 A	690 V, 25 A	220 V, 25 A ³⁾	250 V, 1.1 A ¹⁾																	
			120 V, 25 A ²⁾	125 V, 2.2 A ¹⁾																	
			60 V, 25 A ¹⁾	60 V, 5.0 A ¹⁾																	
Max. rated motor power	690 V, 22 kW 500 V, 15 kW 400 V, 11 kW 240 V, 5.5 kW																				
Short-circuit protection	max. 35 A gG																				
Rated conditional short-circuit current	20 kA																				

Load and Motor Switch / Control Switch

Series 8006/4



Technical Data

Ambient conditions						
Ambient temperature	16 A: Ta = -60 ... +80 °C					
	25 A: Ta = -60 ... +70 °C					
	Rated operational current max.		Ambient temperature max.			
		+40 °C	+50 °C	+60 °C	+70 °C	+80 °C
16 A (min 2.5 mm ²)		Surface temperature max.				
	+80 °C	+80 °C	+80 °C	+95 °C	+130 °C	
	25 A (min 4.0 mm ²)	+80 °C	+80 °C	+95 °C	+130 °C	
					⌀	

Technical Data

Version	USA (UL) / Canada (UL)				
Electrical data					
Rated insulation voltage	max. 690 V AC				
Rated operational voltage	max. 600 V AC / 240 V DC min. 24 V AC / DC				
Rated impulse withstand voltage	6 kV				
Rated operational current	max. 25 A (load and motor switch) max. 10 A (control switch) min. 100 mA (recommended for contact safety: min. one switching operation per week)				
Switching capacity	AC	DC			
	600 V, 25 A		240 V, 25 A ³⁾	125 V, 25 A ²⁾	62.5 V, 25 A ¹⁾
					¹⁾ 1 contact ²⁾ 2 contacts in series ³⁾ 3 contacts in series
Motor switching capacity	600 V, 15 HP		240 V, 5 HP		
	480 V, 15 HP		125 V, 3 HP		
	240 V, 7.5 HP				
	208 V, 7.5 HP				
		Single Phase			
Voltage	227 V	240 V	208 V	120 V	
Current	25 A	25 A	25 A	25 A	
Horse Power	5	3	3	2	
	Control Switch Ratings (UL 508): A600 (AC) N300 (DC)				
Short circuit protection	(40 A Class J				

E9

Load and Motor Switch / Control Switch

Series 8006/4

Technical Data

Version	USA (FM) / Canada (FM)				
Electrical data					
Rated insulation voltage	max. 690 V AC				
Rated operational voltage	max. 600 V AC / 125 V DC min. 24 V AC / DC				
Rated impulse withstand voltage	6 kV				
Rated operational current	T6 max. 40°C up to 4 pole: max. 25 A; Field wiring. Use 75 °C copper conductors. up to 8 pole: max. 15 A; Field wiring. Use 75 °C copper conductors. up to 12 pole: max. 10 A; Field wiring. Use 75 °C copper conductors. T5 max. 55°C up to 4 pole: max. 25 A; Factory wiring. Use 90 °C copper conductors. up to 8 pole: max. 15 A; Factory wiring. Use 90 °C copper conductors. up to 12 pole: max. 10 A; Factory wiring. Use 90 °C copper conductors.				
Switching capacity	max. 25 A (load and motor switch) max. 10 A (control switch) min. 100 mA (recommended for contact safety: min. one switching operation per week)				
	AC	DC			
	600 V, 25 A	125 V, 25 A ²⁾			
		62.5 V, 25 A ¹⁾			
		¹⁾ 2 contacts in series			
		²⁾ 3 contacts in series			
Motor switching capacity	600 V, 15 HP	125 V, 3 HP			
	480 V, 15 HP				
	240 V, 7.5 HP				
	208 V, 7.5 HP				
		Single Phase			
	Voltage	227 V	240 V	208 V	120 V
	Current	25 A	25 A	25 A	25 A
	Horse Power	5	3	3	2
Short circuit protection	Control Switch Ratings (UL 508): A600 (AC) N300 (DC) (40 A Class J				



Technical Data

Version	General
Electrical data	
Short-circuit strength	20 kA
Contacts	max. 12 pole / 6 switching levels *)
	*) The switches have two switching chambers per level. Individual switching levels with 1 or 2 contacts each to form a unit provide an optimal solution for individual applications. The contact chambers are being operated by the ratched wheels in a staggered fashion, thus enabling all around switching without interference.
Service life	mechanical: 200,000 operating cycles electric: 20,000 operating cycles
Mechanical data	
Material	
Enclosure	Epoxy resin
Contacts	Silver-tin oxide, silver-tin oxide gold plated

Load and Motor Switch / Control Switch Series 8006/4



Accessories and Spare Parts

Designation	Figure	Description	Art. no.	Weight kg
Rotary actuator	 05529E00	handle: black protective collar: black Ø 64 mm padlockable labels have to be ordered separately	8602A0731-1-ss 155338	0.062
		handle: red protective collar: yellow Ø 64 mm three times padlockable in OFF-position labels have to be ordered separately	8602A0730-1-rg 155304	0.063
Symbol discs for rotary actuator		Text 0/OFF - I/ON	155750	0.001
		Text 0/OFF • I/ON	155856	0.001
		Text 0 - Betrieb - I	155762	0.001
		Text 0 - I - II	155772	0.001
		Text I - 0 - II	155785	0.001
		label printed acc. to specification, please specify marking	155870	0.002
plain	155871	0.001		
Ex i cover	 14963E00	to connect intrinsically safe circuits (2 pieces)	213610	0.024
IP20 cover	 14705E00	1 piece An IP20 cover is required per contact.	204108	0.003

E9

Load and Motor Switch / Control Switch Series 8006/4

Dimensional Drawings (All Dimensions mm [inches]) - Subject to Alterations

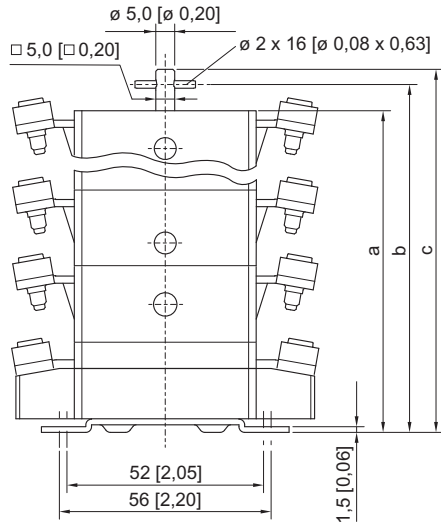

Switching-chamber levels	Dimensions in mm [inches]		
	a	b	c
1	44 [1,73]	52 [2,05]	58 [2,28]
2	64 [2,52]	72 [2,83]	76 [2,99]
3	84 [3,31]	92 [3,62]	98 [3,86]
4	105 [4,13]	112 [4,41]	116 [4,57]
5	125 [4,92]	132 [5,20]	136 [5,35]
6	145 [5,71]	152 [5,98]	156 [6,14]

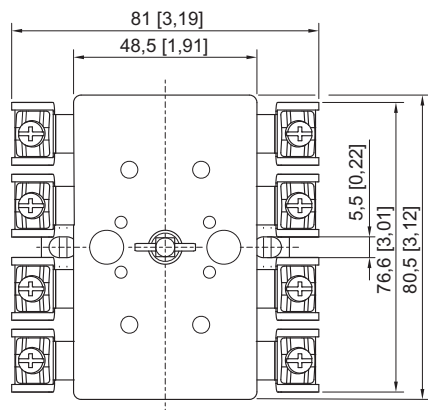

14289E00

Load and motor switches 25 A Series 8006/4

We reserve the right to make alterations to the technical data, dimensions, weights, designs and products available without notice. The illustrations cannot be considered binding.